

TX-W32/28D5F/P Service Manual

Safety

Specifications

Parts List

Service
Information

Adjustments

Self Check

Service Hints

Mechanical
View

Disassembly

Location of
Controls

Waveforms

Block Diagrams

Schematic Diagrams

PCB Views

Service Support

Service and repair of this product is supported by Panasonic's LUCI interface.

This interface provides a link between the TV and a standard PC to allow a number of diagnostic and control functions to be performed.

For more details contact your local Panasonic company.

BACK

EXIT

Audio

Control

Power supply

Video

BACK

D - PCBs

E - PCB

F - PCBs

G - PCB

H - PCB

M - PCB

Y - PCB

BACK

D - Schematics

E - Schematics

F - Schematic

G - Schematic

H - Schematic

M - Schematics

Y - Schematics

BACK

Service Manual



Colour Television

TX-W32D5F/P

TX-W28D5F/P

EURO - 5 Chassis

SPECIFICATIONS

(Information in brackets { } refer to TX-W28D5F/P)

Power Source: 220-240V AC, 50Hz

Power Consumption: 235W {204W}

Aerial Impedance: 75Ω unbalanced, Coaxial Type

Stand-by Power Consumption: 1,9W

Receiving System: PAL B/G, H, D/K, PAL-525/60
SECAM B/G, D/K
M.NTSC
NTSC (AV only)

Receiving Channels:
VHF E2-E12 VHF H1-H2 (ITALY)
VHF A-H (ITALY) VHF R1-R2
VHF R3-R5 VHF R6-R12
UHF E21-E69 CATV (S01-S05)
CATV S1-S10 (M1-M10) CATV S11-S20 (U1-U10)
CATV S21-S41 (HYPERBAND)

Intermediate Frequency:
Video 38,9MHz
Audio 33,4MHz, 33,16MHz
32,4MHz, 33,05MHz
32,66MHz
Colour 34,47MHz (PAL)
34,5MHz, 34,65MHz (SECAM)

Video/Audio Terminals:
AUDIO MONITOR OUT
AV1 IN
AV1 OUT
Audio (RCAX2) 500mV rms 1kΩ
Video (21 pin) 1V p-p 75Ω
Audio (21 pin) 500mV rms 10kΩ
RGB (21 pin)
Video (21 pin) 1V p-p 75Ω
Audio (21 pin) 500mV rms 1kΩ

AV2 IN
Video (21 pin) 1V p-p 75Ω
Audio (21 pin) 500mV rms 10kΩ
S-Video IN (21 pin) Y: 1V p-p 75Ω
C: 0.3V p-p 75Ω
AV2 OUT
Video (21 pin) 1V p-p 75Ω
Audio (21 pin) 500mV rms 1kΩ
Selectable Output (21 pin)

AV3 IN
S-Video IN (4-pin) Y: 1V p-p 75Ω
C: 0.3V p-p 75Ω
Audio(RCAx2) 500mV rms 10kΩ
Video (RCAx1) 1V p-p 75Ω

AV4 IN
Video (21 pin) 1V p-p 75Ω
Audio (21 pin) 500mV rms 10kΩ
S-Video IN (21 pin) Y: 1V p-p 75Ω
C: 0.3V p-p 75Ω
AV4 OUT
Video (21 pin) 1V p-p 75Ω
Audio (21 pin) 500mV rms 1kΩ

High Voltage: 32kV ±1kV {30,5kV ±1kV}

Picture Tube: W76LNR585X05 {W66EHK51X81}
Audio Output: 2 x 20W Left/Right
26W Super 3D Bass
(Music Power) 8Ω Impedance

Headphones: 8Ω Impedance
3,5 mm

Accessories Supplied: Remote Control
2 x R6 (UM3) Batteries

Dimensions:
Height: 577,6mm {523,2mm}
Width: 778mm {684mm}
Depth: 535mm {510mm}

Net weight: 53,5kg {38,5kg}

Specifications are subject to change without notice.
Weights and dimensions shown are approximate.

NOTE: This Service Manual should be used in conjunction with the EURO - 5 Technical Guide.

CONTENTS

SAFETY PRECAUTIONS.....	2
SERVICE HINTS.....	3
SERVICE POSITION.....	4
ADJUSTMENT PROCEDURE AND SELF-CHECK	5
WAVEFORM PATTERN TABLE	6
ALIGNMENT SETTINGS.....	7
BLOCK DIAGRAMS	8
PARTS LOCATION	12
REPLACEMENT PARTS LIST	13
SCHEMATIC DIAGRAMS	32
CONDUCTOR VIEWS.....	44

SAFETY PRECAUTIONS

GENERAL GUIDE LINES

1. It is advisable to insert an isolation transformer in the a.c. supply before servicing a hot chassis.
2. When servicing, observe the original lead dress in the high voltage circuits. If a short circuit is found, replace all parts that have been overheated or damaged by the short circuit.
3. After servicing, see that all the protective devices such as insulation barriers, insulation papers, shields and isolation R-C combinations are correctly installed.
4. When the receiver is not being used for a long period of time, unplug the power cord from the a.c. outlet.
5. Potentials as high as 33kV {31,5kV }are present when this receiver is in operation. Operation of the receiver without the rear cover involves the danger of a shock hazard from the receiver power supply. Servicing should not be attempted by anyone who is not familiar with the precautions necessary when working on high voltage equipment. Always discharge the anode of the tube.
6. After servicing make the following leakage current checks to prevent the customer from being exposed to shock hazard.

LEAKAGE CURRENT COLD CHECK

1. Unplug the a.c. cord and connect a jumper between the two prongs of the plug.
2. Turn on the receiver's power switch.
3. Measure the resistance value with an ohmmeter, between the jumpered a.c. plug and each exposed metallic cabinet part on the receiver, such as screw heads, aerials, connectors, control shafts etc. When the exposed metallic part has a return path to the chassis, the reading should be between 4M ohm and 20M ohm. When the exposed metal does not have a return path to the chassis, the reading must be infinite.

LEAKAGE CURRENT HOT CHECK

1. Plug the a.c. cord directly into the a.c. outlet. Do not use an isolation transformer for this check.
2. Connect a 2k Ω 10W resistor in series with an exposed metallic part on the receiver and an earth, such as a water pipe.
3. Use an a.c. voltmeter with high impedance to measure the potential across the resistor.
4. Check each exposed metallic part and check the voltage at each point.
5. Reverse the a.c. plug at the outlet and repeat each of the above measurements.

6. The potential at any point should not exceed 1,4 Vrms. In case a measurement is outside the limits specified, there is a possibility of a shock hazard, and the receiver should be repaired and rechecked before it is returned to the customer.

X-RADIATION WARNING

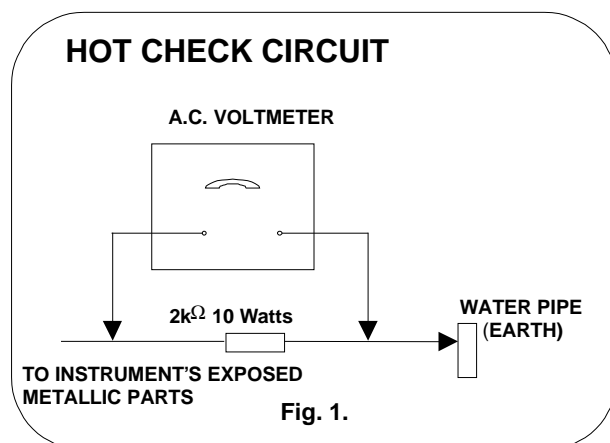

Fig. 1.

1. The potential sources of X-Radiation in TV sets are the high voltage section and the picture tube.
2. When using a picture tube test jig for service, ensure that the jig is capable of handling 33kV {31,5kV} without causing X-Radiation.

NOTE: It is important to use an accurate periodically calibrated high voltage meter.

1. Set the brightness to minimum.
2. Measure the high voltage. The meter should indicate:- 32kV \pm 1kV {30,5kV \pm 1kV }. If the meter indication is out of tolerance, immediate service and correction is required to prevent the possibility of premature component failure.
3. To prevent any X-Radiation possibility, it is essential to use the specified tube.

SERVICE HINTS

How to remove the rear cover

1. Remove the 10 (9) as shown in **Fig.2.**

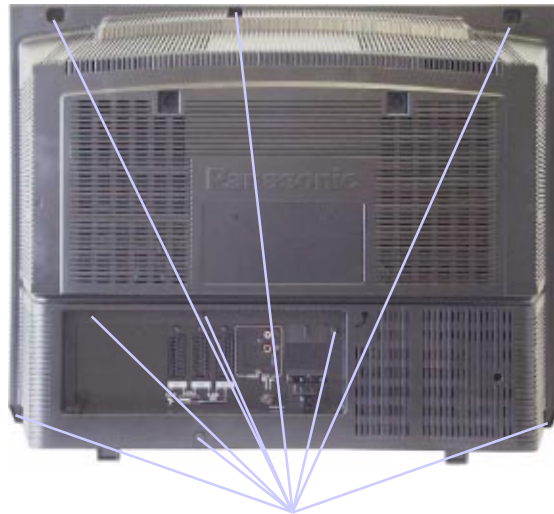

Screws
Fig.2.

LOCATION OF CONTROLS

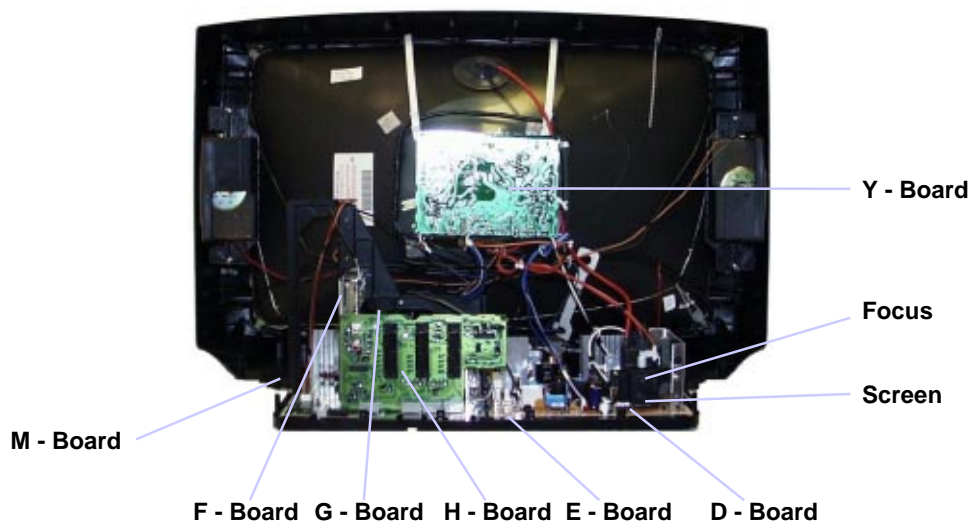

Fig.3.

HOW TO MOVE THE CHASSIS INTO SERVICE POSITION

1. Hold and lift the rear of the chassis and gently pull the chassis toward you, as shown in **Fig.4**.
2. Release the respective wiring clips and rotate the chassis vertically through 90°, anti-clockwise.
3. Locate the base of the chassis frame into the hole **(B)**, shown in **Fig.6**.
4. Clip the chassis frame onto the bead clasper **(A)**, as shown in **Fig.5**.
5. After servicing replace the bead clasper and ensure all wiring is returned to its original position before returning the receiver to the customer.

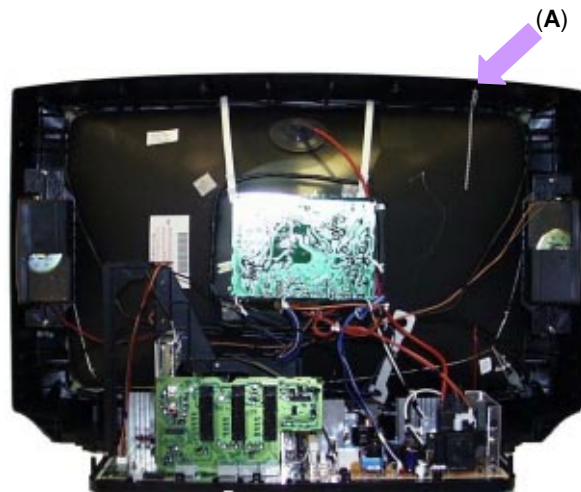

Fig.4.

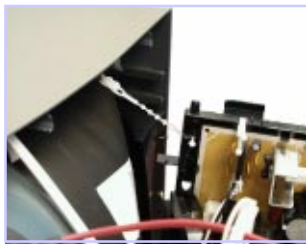

Fig.5.

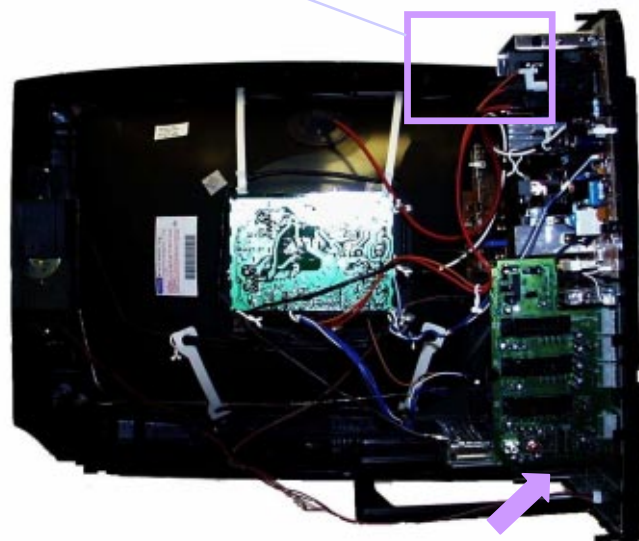

Fig.6.

(B)

ADJUSTMENT PROCEDURE

Item / Preparation	Adjustments
+B SET-UP 1. Receive a Greyscale signal. 2. Set the controls :- Brightness Minimum Contrast Minimum Volume Minimum	1. Confirm the following voltages. D-Board D3 PIN5 147V ± 3V D12 PIN5 5V ± 0,3V D13 PIN1 40V ± 4V D3 PIN4 230V ± 10V D3 PIN4 205V ± 10V D3 PIN4 190V ± 10V D3 PIN4 190V ± 10V D14 PIN5 5V ± 0,5V D12 PIN7 15V ± 2V D12 PIN9 15V ± 2V D11 PIN8 12V ± 2V D11 PIN10 33V ± 3V E-Board U8A E19-PIN8 8V ± 0,5V U9 IC3801-PIN3 9V ± 0,5V U12 E22-PIN8 12V ± 0,5V STD5VE26-PIN4 5V ± 0,5V U15 E23-PIN8 15V ± 1V U15 E23-PIN9 -15V ± 1V U33 E22-PIN10 33V ± 4V U40 E24-PIN1 40V ± 3V U5B E19-PIN5 5V ± 0,5V
Cut Off 1. Receive a Greyscale signal. 2. Degauss the tube externally. 3. Set the TV into Service Mode 1. 4. Select Cut off mode.	Adjust the screen VR until the display shows "O.K."

SELF CHECK

Self-check is used to automatically check the bus lines and hexadecimal code of the TV set. To get into the Self-Check mode press the down (-v) button on the customer controls at the front of the set, at the same time pressing the **STATUS** button on the remote control, and the screen will show :-

VPC	O.K.		
TUN	O.K.	PCB	O.K.
E2	O.K.		
DPL	--	Cab	O.K.
CIP1	O.K.		
CIP2	O.K.	Sum	Factory use only
VP	O.K.		
DFU	O.K.		
COL	O.K.		
PIP	O.K.		
DIS	O.K.		
OPTION 1	BD	{BD}	
OPTION 2	FD	{DD}	
OPTION 3	1F	{1F}	
OPTION 4	08	{08}	
OPTION 5	FF	{FF}	
OPTION 6	63	{63}	

Self Check is also used to automatically check the bus lines and hexadecimal code of the TV set. If the CCU ports have been checked and found to be incorrect or not located then "--" will appear in place of "O.K.". For more in-depth TV diagnostics use the **LUCI** interface as listed below.

Service Aids

To aid in the service of our current chassis there are a number of Service Aids which have been made available.

- LUCI** interface kit (Linked Utility Computer Interface)
 Part number: TZS6EZ002
 This contains interface and cables for connecting TV service connector and a PC as well as diagnostic software. As new models are introduced upgrade software will become available.
- VICI** (Visual Interactive Computer Information)
 These C.D.'s contain multimedia documentation providing quick access to service information.
 Part No. TZS7EZ006 & TZS7EZ005
 - Service Manuals
 - Instruction Books
 - Technical Information
- TASMIN** (Technically Advanced System for Multimedia Interactive Notes)
 As well as providing a first step towards more interactive training this product also achieves quick access to Technical Information.

WAVEFORM PATTERN TABLE

NOTE: All waveforms have been taken using a standard colour bar pattern.

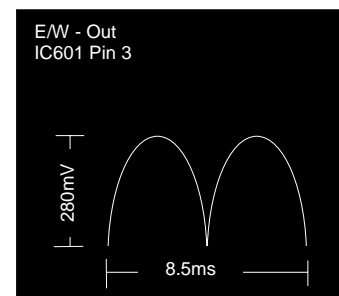
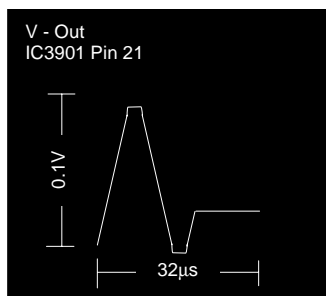
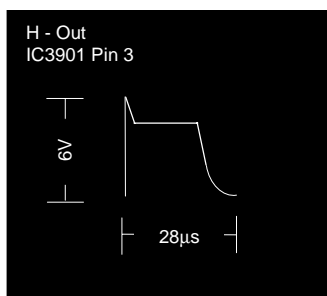
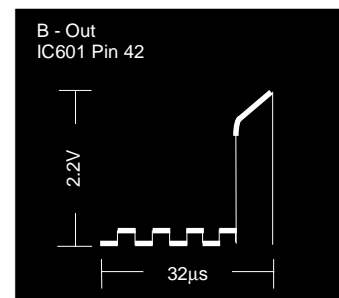
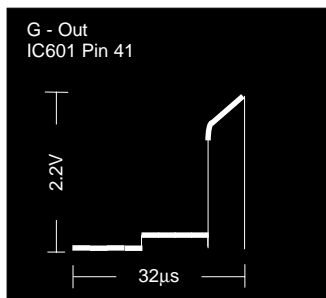
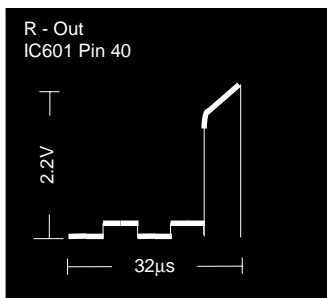
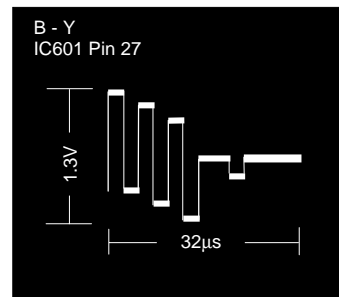
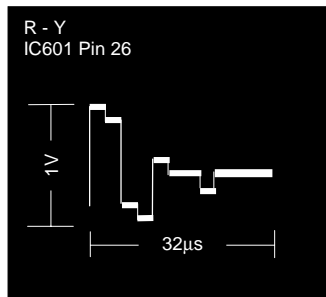
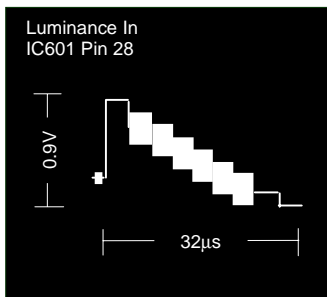
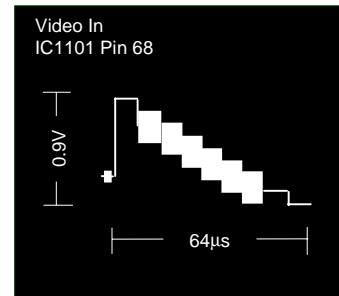
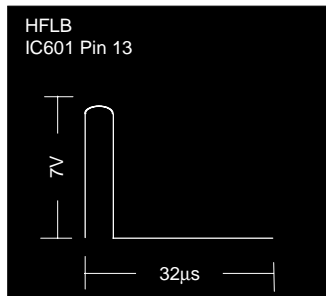
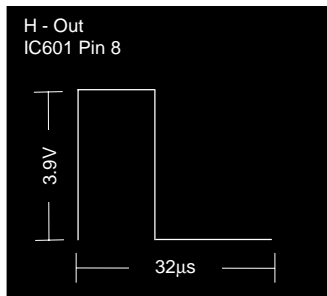
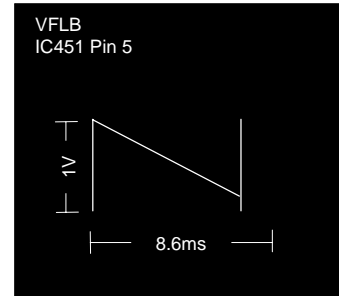
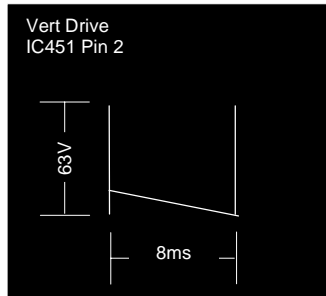
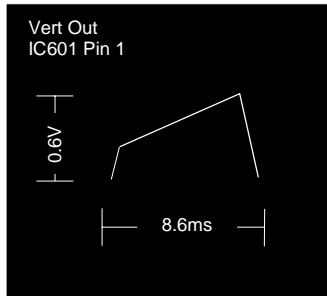

ALIGNMENT SETTINGS:

(The figures below are nominal and used for representative purposes only.)

1. Set the Bass to maximum position, set the Treble to minimum position, press the down button (- / v) on the customer controls at the front of the TV and at the same time press the **INDEX** button on the remote control, this will place the TV into the Service Mode.
2. Press the **RED / GREEN** buttons to step up / down through the functions.
3. Press the **YELLOW / BLUE** buttons to alter the function values.
4. Press the **STR** button after each adjustment has been made to store the required values.
5. To exit the Service Mode, press the "**N**" button.

Alignment Function		Settings / Special features
Horizontal Position	H-Pos +020	Optimum setting.
Vertical Position	V-Pos +024	Optimum setting.
Horizontal Amplitude	H-Amp +049	Optimum setting.
Vert. Amplitude	V-Amp +029	Optimum setting.
EW-amplitude	E/W-Amp1 +022	Optimum setting.
EW-amplitude	E/W-Amp2 +000	Optimum setting.
Trapezium-comp	Trapez-1 +033	Optimum setting.
Horizontal-Parallel	H-Parallel +032	Optimum setting.
Vertical Linearity	V-Lin +004	Optimum setting.
DVCO	DVCO 000	Receive a PAL Colour Bar Pattern. For DVCO alignment press " Blue " button, wait until the colours are stable and press " STR ".
Cut-off DC	Cut-off O.K.	To adjust Cutoff adjust the screen VR until the display shows "O.K."
Highlight	High 0031 0031 0031	Contrast Maximum A.I. Off Adjust for optimum setting.
Sub-Brightness	Sub-Brightness 000	Optimum setting.

VIDEO BLOCK DIAGRAM

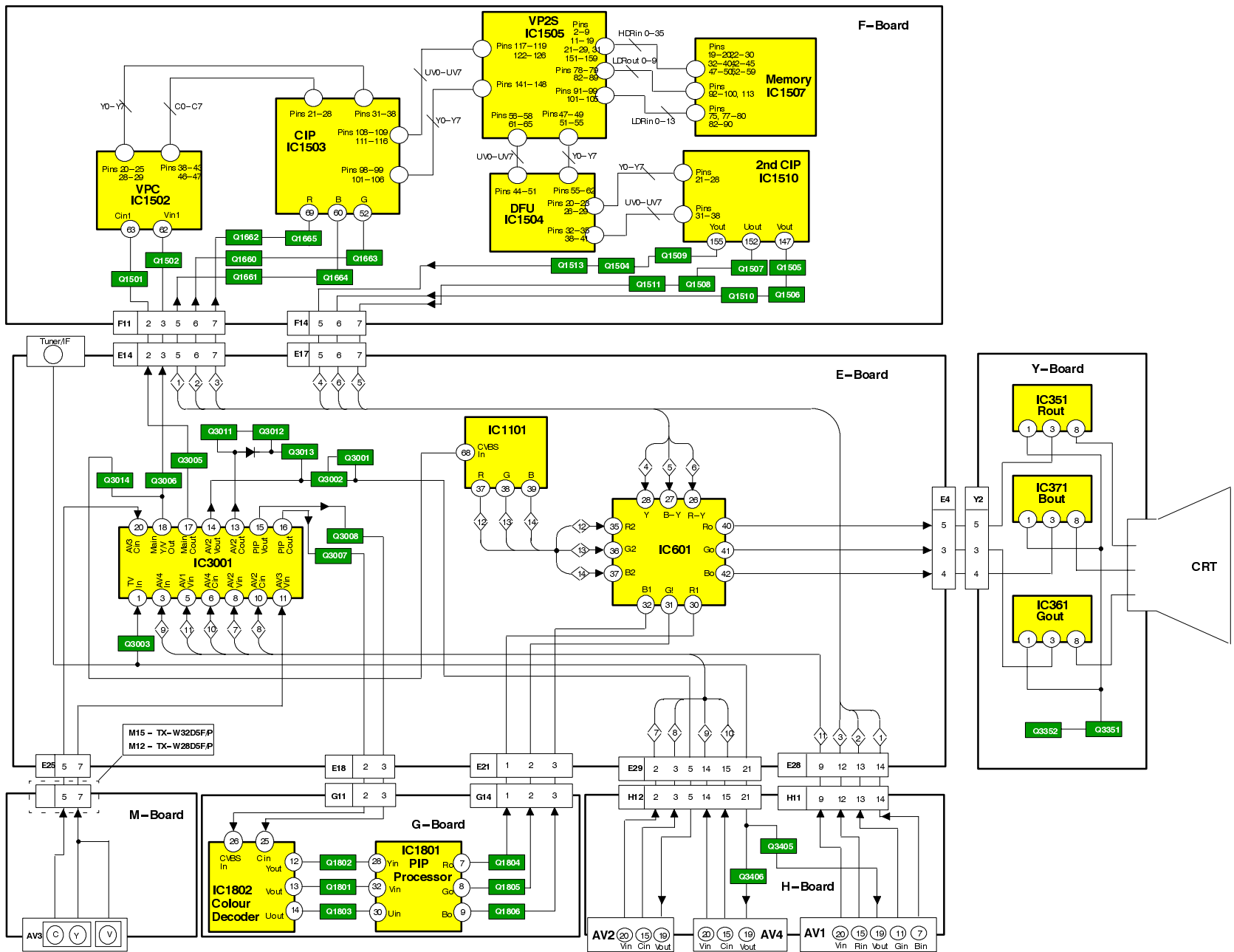

AUDIO BLOCK DIAGRAM

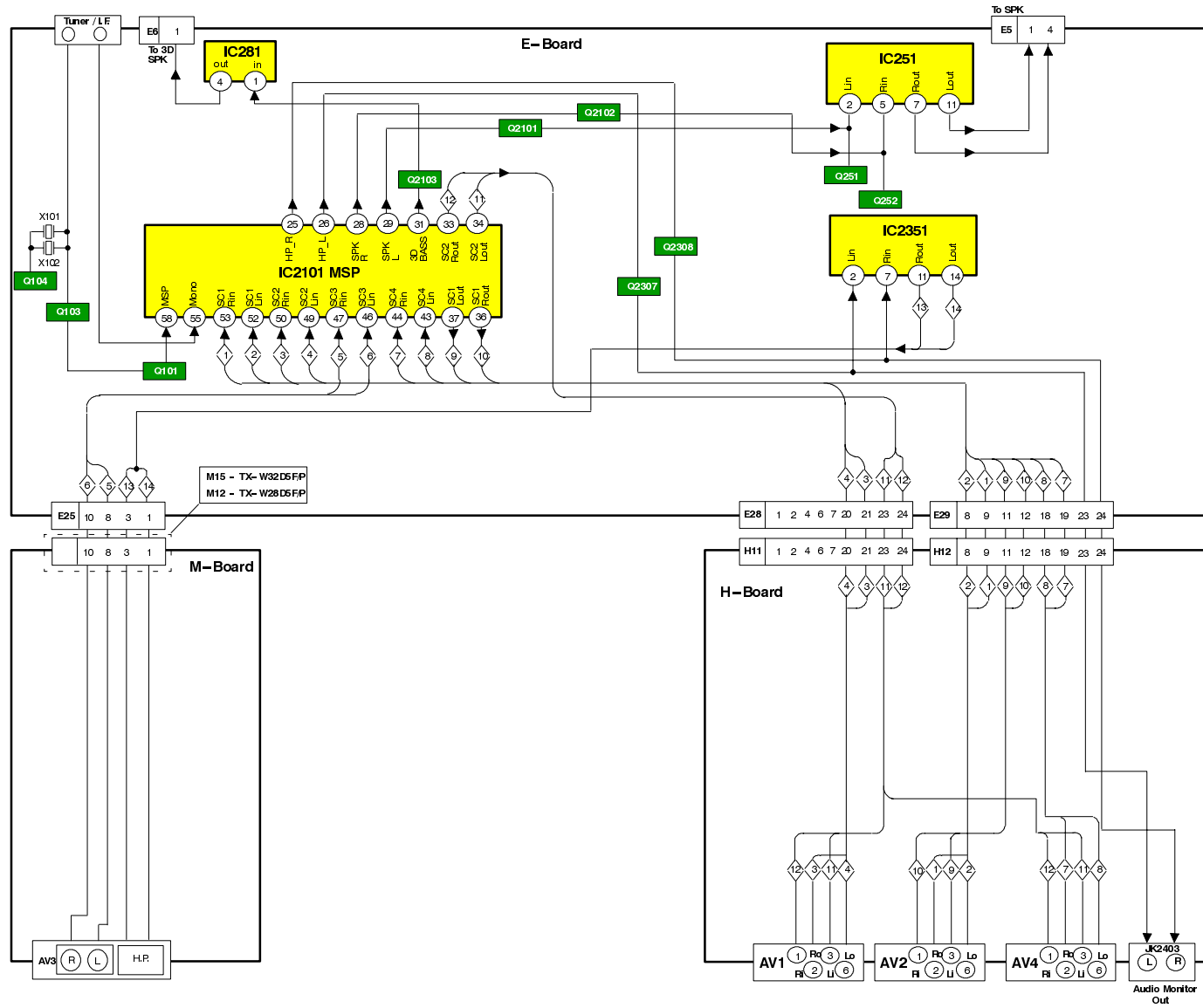

CONTROL BLOCK DIAGRAM

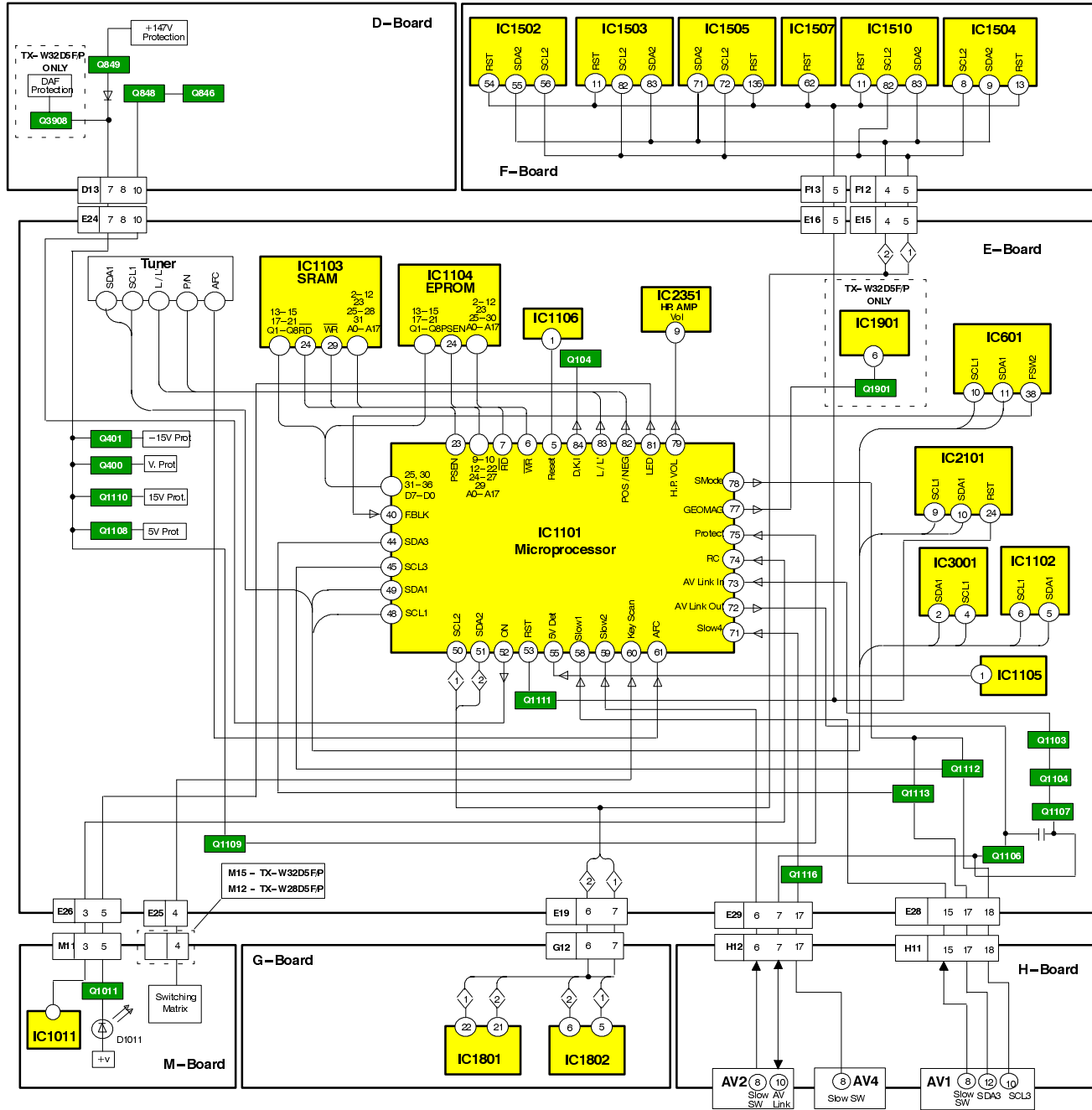

POWER SUPPLY & DEFLECTION BLOCK DIAGRAM

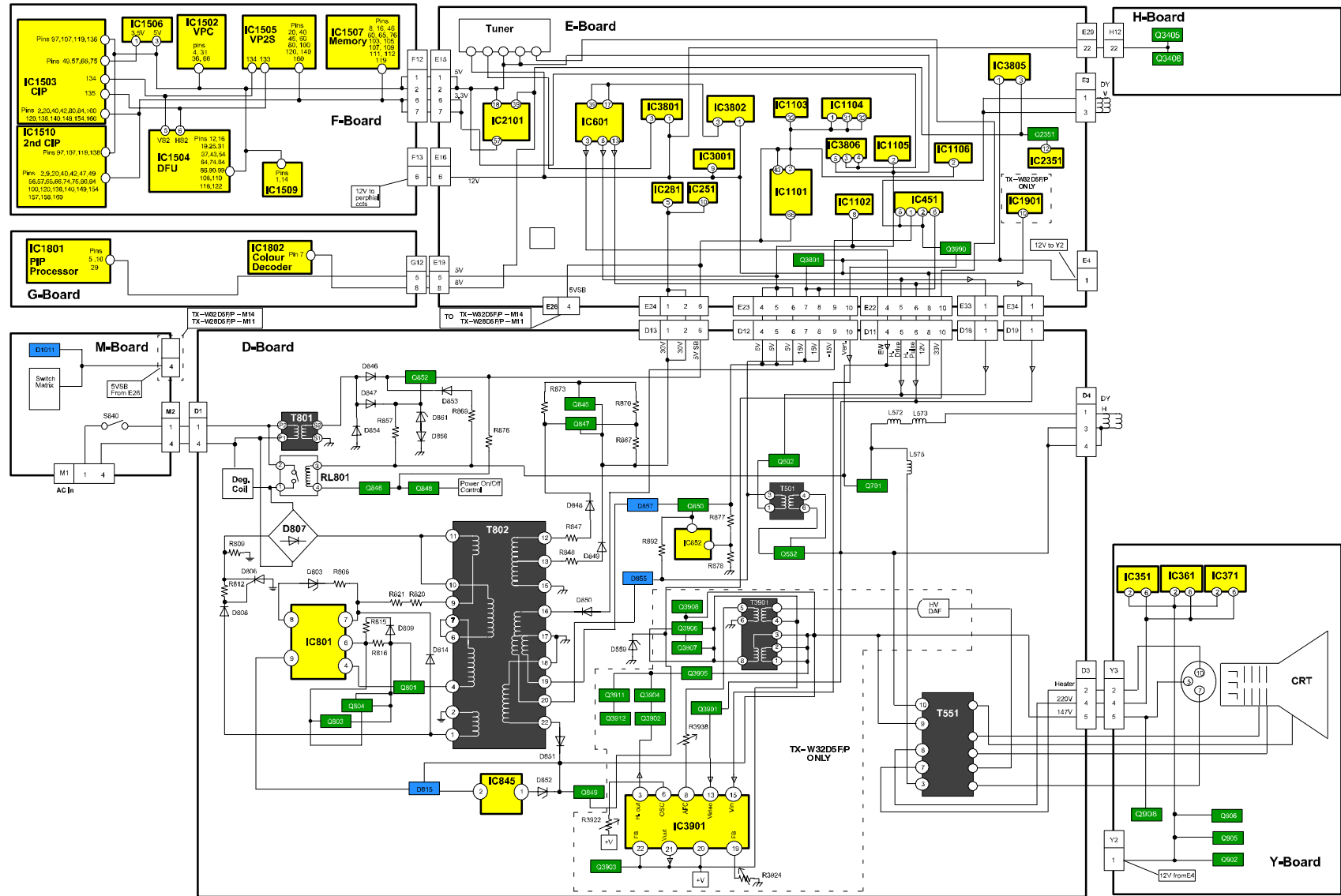

PARTS LOCATION



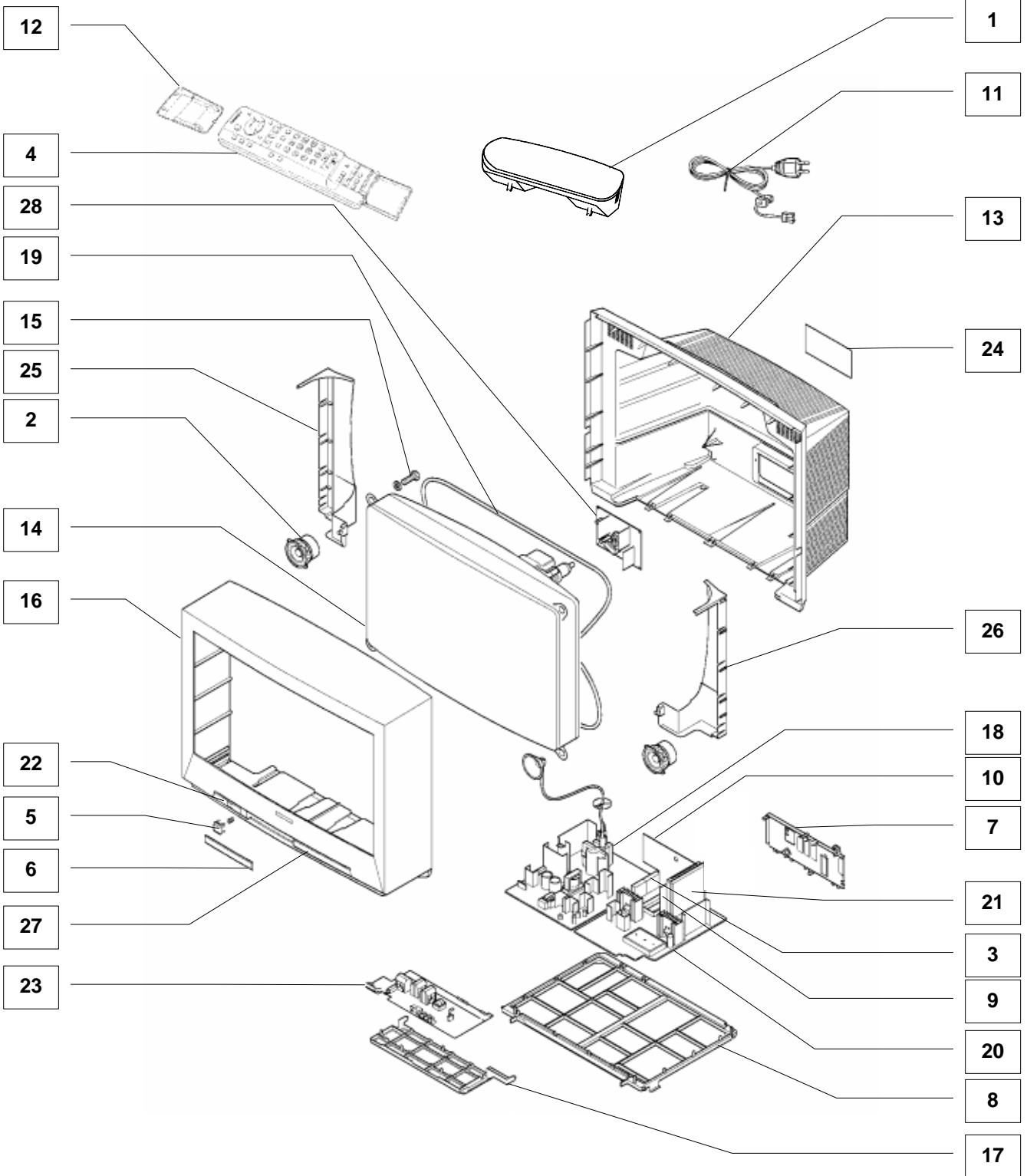





NOTE:
The numbers on the exploded view below refer to the mechanical section of the Replacement Parts List.





REPLACEMENT PARTS LIST

Important Safety Notice

Components Identified by  mark have special characteristics important for safety.
 * When replacing any of these components, use only manufacturers specified parts.
 In case of ordering these spare parts, please always add the complete Model-Type number to your order.

Cct Ref	Parts Number	Description
COMMON PARTS		
MECHANICAL PARTS		
1	EABG10P502A2	3D WOOFER
2	EASG8P525A2	SPEAKER
3	ENG29505G	TUNER 
4	EUR511220	REMOTE CONTROL
5	TBX8E057	POWER BUTTON
6	TKP8E1239	DOOR LID
7	TKP8E1253-3	REAR AV PANEL
8	TMX8E027	CHASSIS FRAME
9	TNPA0877AB	G P.C.B. 
10	TNPA1047AC	H P.C.B. 
11	TSX8E0027	POWER CORD 
12	UR51EC904A	BATTERY COVER (REMOTE)
MISCELLANEOUS COMPONENTS		
	832AG11D-ESL	IC SOCKET
	PLCC-84-T	84 PIN IC SOCKET
	TBM8E1726	PANASONIC BADGE
	TBM8E1860	PRESET PANEL
	TBM8E1861	HOLOGRAM LABEL
	TBM8E1863	REAR AV LABEL
	TEK6940	LID CATCH
	TKP8E1240	SMOKED PANEL
	TKP8E1241	LED PANEL
	TMW8E030	LED HOLDER
	TMX8E025	P.C.B. BRACKET
	UM-3DJ-2P	BATTERY PACK
	VP19001	C.R.T. BUSH
	ZTBZAD550A	ANODE CABLE
RL801	TSE1885-1	RELAY 
R805	232266296706	THERMISTOR
SOD9	31221212478	FIX CLIP
SOD1	31221212478	FIX CLIP
INSTRUCTION BOOKS		
	TQB8E2676MN2	BULG./ROMANIAN 
	TQB8E2676PQ2	POLISH/HUNG. 
	TQB8E2676RU2	CZECH/ENGLISH 
I.C.s		
IC251	LA4282	AUDIO OUTPUT
IC281	TDA2030AV	AUDIO AMPLIFIER
IC351	TDA6111Q-N4	RGB OUTPUT
IC361	TDA6111Q-N4	RGB OUTPUT
IC371	TDA6111Q-N4	RGB OUTPUT
IC381	TL431ACLPM	REGULATOR
IC451	LA7845N	VERTICAL OUTPUT
IC601	TDA9330HN1G	VIDEO PROCESSOR

Cct Ref	Parts Number	Description
IC801	AN8029	POWER SUPPLY
IC845	SE140N	ERROR AMPLIFIER
IC852	TL431ACLPM	REGULATOR
IC1011	RPM-637CBRL	LED RECEIVER
IC1101	SDA5450C47-1	MICRO PROCESSOR
IC1103	M5M51008BP	SRAM
IC1104	27C2001-K03	EPROM *
IC1105	MN1381-T(TA)	RESET
IC1106	MN1381-R(TA)	RESET
IC1502	VPC3215CB4TP	VPC
IC1503	MB87F1720	CIP
IC1504	FJB007S	DFU
IC1505	MB87F2131	VP2S
IC1506	AN77L035M-E1	3.5V REGULATOR
IC1507	MB87H2010	MEMORY
IC1509	TLC2932IPWL	CLOCK CONVERTOR
IC1510	MB87F1720	CIP
IC1801	SDA9288XEGERG	PIP PROCESSOR
IC1802	TDA9143-N1	COLOUR DECODER
IC2101	MSP3410DPPB4	AUDIO PROCESSOR
IC2351	AN7108	H.P. AMPLIFIER
IC3001	TEA6415C	VIDEO SWITCH
IC3801	AN7809FLB	9V REGULATOR
IC3802	AN7708FLB	8V REGULATOR
IC3805	AN7808LB	8V REGULATOR
IC3806	SI-3033C	3.5V REGULATOR
FUSES		
F840	XBA2C50TH15	FUSE 
F845	TR5-T3150	FUSE 
F846	TR5-T1250	FUSE 
F8401	EYF52BC	FUSE HOLDER
F8402	EYF52BC	FUSE HOLDER
DIODES		
D001	MA4020	DIODE
D002	MA4020	DIODE
D252	MA165TA5	DIODE
D253	MA700TA5	DIODE
D254	MA700TA5	DIODE
D255	MA165TA5	DIODE
D282	MA165TA5	DIODE
D284	MA165TA5	DIODE
D285	MA165TA5	DIODE
D286	MA165TA5	DIODE
D351	ERA15-04V3	DIODE
D352	ERA15-04V3	DIODE
D361	ERA15-04V3	DIODE
D362	ERA15-04V3	DIODE
D371	ERA15-04V3	DIODE
D372	ERA15-04V3	DIODE
D387	MA2160LFS	DIODE
D400	MA4104	DIODE
D401	MA165TA5	DIODE

Cct Ref	Parts Number	Description
D402	MA165TA5	DIODE
D404	EU02AV1	DIODE
D405	MA165TA5	DIODE
D408	MA165TA5	DIODE
D502	1SS254T-77	DIODE
D503	EU02	DIODE
D504	EU02	DIODE
D505	ERA81004V3	DIODE
D556	AU02V0	DIODE
D559	MTZJT-7736A	DIODE
D560	1SS252T-77	DIODE
D563	RH3GLF102	DIODE
D571	FMV-3GULF730	DIODE
D575	1SS252T-77	DIODE
D601	MA29TA5	DIODE
D603	MA4075	DIODE
D605	MA4062	DIODE
D607	MA165TA5	DIODE
D610	MA4043	DIODE
D611	MA165TA5	DIODE
D612	MA165TA5	DIODE
D615	MA165TA5	DIODE
D616	MA178TA5	DIODE
D617	MTZJT-779.1C	DIODE
D618	MTZJT-779.1C	DIODE
D620	MA165TA5	DIODE
D651	MA165TA5	DIODE
D701	AU02V0	DIODE
D803	MTZJT-7712C	DIODE
D806	TF361MALF3	DIODE
D807	RBV-608LF-B	DIODE
D808	MA165TA5	DIODE
D809	ERA22-02V3	DIODE
D810	MA2180BLFS	DIODE
D812	MTZJT-775.6B	DIODE
D813	MA700TA5	DIODE
D814	AU01ZV0	DIODE
D815	PC123FY2	DIODE
D817	D5L60F4015	DIODE
D818	TMPG10G3	DIODE
D819	ERA81004V3	DIODE
D820	MA4100	DIODE
D821	EU02AV0	DIODE
D845	MA165TA5	DIODE
D846	EK04V0	DIODE
D847	ERA15-01V3	DIODE
D848	EU02	DIODE
D849	FMGG26S	DIODE
D850	ERB32-02E	DIODE
D851	FMGG2CSLF116	DIODE
D852	MA4062	DIODE
D853	1N4150T-77	DIODE
D854	ERA15-01V3	DIODE
D855	D10SC6MRL	DIODE
D856	MA165TA5	DIODE
D857	FML22SLF610	DIODE
D860	1SS254T-77	DIODE
D861	MTZJT-775.1C	DIODE
D901	1SS254T-77	DIODE
D902	1SS254T-77	DIODE
D903	1SS254T-77	DIODE
D910	R2KNLFA1	DIODE
D1011	LN81RPHL	DIODE
D1102	MA4051	DIODE
D1103	MA4051	DIODE
D1104	MA165TA5	DIODE

Cct Ref	Parts Number	Description
D1105	MA165TA5	DIODE
D1107	MA165TA5	DIODE
D1109	MA165TA5	DIODE
D1110	MA165TA5	DIODE
D1112	MA165TA5	DIODE
D1501	MA151ATX	DIODE
D1801	MA151ATX	DIODE
D1802	MA151ATX	DIODE
D2101	MTZJT-7712C	DIODE
D2102	MTZJT-7712C	DIODE
D2351	MTZJT-775.6B	DIODE
D3006	MA4100	DIODE
D3008	MA723TA5	DIODE
D3009	MA170	DIODE
D3011	MA858TA5	DIODE
D3351	1SS254T-77	DIODE
D3352	MA165TA5	DIODE
D3353	MA165TA5	DIODE
D3354	MA165TA5	DIODE
D3401	MTZJT-7712C	DIODE
D3402	MTZJT-7712C	DIODE
D3803	MA4043	DIODE
D3804	MTZJT-778.2A	DIODE
D3805	ERA81004V3	DIODE
D3990	MTZJT-7724D	DIODE
TRANSISTORS		
Q101	BC847B	TRANSISTOR
Q103	BC847B	TRANSISTOR
Q104	BC847B	TRANSISTOR
Q251	2SD1328STX	TRANSISTOR
Q252	2SD1328STX	TRANSISTOR
Q253	BC847B	TRANSISTOR
Q254	BC857B	TRANSISTOR
Q281	2SD1328STX	TRANSISTOR
Q282	BC857B	TRANSISTOR
Q400	BC847B	TRANSISTOR
Q401	BC847B	TRANSISTOR
Q502	2SC2925STA	TRANSISTOR
Q552	2SC5144LB230	TRANSISTOR
Q553	2SC1473-RN	TRANSISTOR
Q554	2SC1473-RN	TRANSISTOR
Q601	BC857B	TRANSISTOR
Q602	BC857B	TRANSISTOR
Q603	BC857B	TRANSISTOR
Q604	BC857B	TRANSISTOR
Q607	BC857B	TRANSISTOR
Q608	BC857B	TRANSISTOR
Q701	2SK2538000LB	TRANSISTOR
Q801	2SK1365LB106	TRANSISTOR
Q803	2SD965-R	TRANSISTOR
Q804	2SA719-TA	TRANSISTOR
Q845	2SA684R	TRANSISTOR
Q849	2SA1018QTA	TRANSISTOR
Q850	2SD1474PLB	TRANSISTOR
Q852	2SC1318-S	TRANSISTOR
Q902	BC847B	TRANSISTOR
Q903	BC847B	TRANSISTOR
Q904	BC857B	TRANSISTOR
Q905	BC847B	TRANSISTOR
Q906	BC847B	TRANSISTOR
Q907	BC857B	TRANSISTOR
Q908	2SA1535ARLB	TRANSISTOR
Q909	2SC3944ARLB	TRANSISTOR
Q1011	BC557B/126	TRANSISTOR
Q1103	BC847B	TRANSISTOR
Q1104	BC847B	TRANSISTOR

Cct Ref	Parts Number	Description
Q1105	BC847B	TRANSISTOR
Q1106	BC847B	TRANSISTOR
Q1107	BC847B	TRANSISTOR
Q1108	BC847B	TRANSISTOR
Q1109	BC847B	TRANSISTOR
Q1110	BC847B	TRANSISTOR
Q1111	BC847B	TRANSISTOR
Q1112	BC847B	TRANSISTOR
Q1113	BC847B	TRANSISTOR
Q1116	BC847B	TRANSISTOR
Q1118	BC857B	TRANSISTOR
Q1501	BC857B	TRANSISTOR
Q1502	BC857B	TRANSISTOR
Q1503	BC847B	TRANSISTOR
Q1504	BC847B	TRANSISTOR
Q1505	BC847B	TRANSISTOR
Q1506	BC847B	TRANSISTOR
Q1507	BC847B	TRANSISTOR
Q1508	BC847B	TRANSISTOR
Q1509	BC847B	TRANSISTOR
Q1510	BC847B	TRANSISTOR
Q1511	BC847B	TRANSISTOR
Q1513	BC857B	TRANSISTOR
Q1660	BC847B	TRANSISTOR
Q1661	BC847B	TRANSISTOR
Q1662	BC847B	TRANSISTOR
Q1663	BC847B	TRANSISTOR
Q1664	BC847B	TRANSISTOR
Q1665	BC847B	TRANSISTOR
Q1666	BC847B	TRANSISTOR
Q1667	BC847B	TRANSISTOR
Q1801	BC847B	TRANSISTOR
Q1802	BC847B	TRANSISTOR
Q1803	BC847B	TRANSISTOR
Q1804	BC857B	TRANSISTOR
Q1805	BC857B	TRANSISTOR
Q1806	BC857B	TRANSISTOR
Q2101	BC860B	TRANSISTOR
Q2102	BC860B	TRANSISTOR
Q2103	BC860B	TRANSISTOR
Q2301	BC847B	TRANSISTOR
Q2302	BC847B	TRANSISTOR
Q2305	BC857B	TRANSISTOR
Q2307	BC860B	TRANSISTOR
Q2308	BC860B	TRANSISTOR
Q2351	BC847B	TRANSISTOR
Q2352	BC847B	TRANSISTOR
Q3001	BC857B	TRANSISTOR
Q3002	BC847B	TRANSISTOR
Q3003	BC847B	TRANSISTOR
Q3005	BC847B	TRANSISTOR
Q3006	BC847B	TRANSISTOR
Q3007	BC847B	TRANSISTOR
Q3008	BC847B	TRANSISTOR
Q3010	BC857B	TRANSISTOR
Q3011	BC857B	TRANSISTOR
Q3012	BC847B	TRANSISTOR
Q3013	BC847B	TRANSISTOR
Q3014	BC847B	TRANSISTOR
Q3351	BC847B	TRANSISTOR
Q3352	BC857B	TRANSISTOR
Q3401	BC847B	TRANSISTOR
Q3402	BC847B	TRANSISTOR
Q3403	BC847B	TRANSISTOR
Q3404	BC847B	TRANSISTOR
Q3405	BC847B	TRANSISTOR

Cct Ref	Parts Number	Description
Q3406	BC847B	TRANSISTOR
Q3801	2SD1474PLB	TRANSISTOR
Q3990	BC847B	TRANSISTOR
TRANSFORMERS		
T501	ETH19Y187AY	TRANSFORMER
T801	ETP35KAN619U	TRANSFORMER
T802	ETS49AH1W7AD	TRANSFORMER
COILS		
L002	EXCELD35V	COIL
L003	EXCELD35V	COIL
L004	EXCELSA35T	COIL
L005	TLT100K991R	COIL
L007	EXCELD35V	COIL
L008	ELJFC2R2KF	COIL
L009	ELJFC2R2KF	COIL
L251	EXCELSA35T	COIL
L252	EXCELSA35T	COIL
L253	EXCELSA35T	COIL
L254	EXCELSA35T	COIL
L281	EXCELSA35T	COIL
L282	EXCELSA35T	COIL
L351	TAXK0036	DELAY LINE
L353	TLT120K991R	COIL
L361	TAXK0036	DELAY LINE
L371	TAXK0036	DELAY LINE
L373	TLT120K991R	COIL
L381	TLT220K991R	COIL
L501	ELELN101KA	COIL
L556	EXCELD35C	COIL
L572	ELHKLBO25B	COIL
L573	ELHKLBO26B	COIL
L575	ELC18B331E	COIL
L601	EXCELD25V	COIL
L602	EXCELD35V	COIL
L603	TLT033K991R	COIL
L604	ELEXT2R7KA	COIL
L605	ELEXT2R7KA	COIL
L606	ELEXT2R7KA	COIL
L607	ELEXT2R7KA	COIL
L701	ELC18B801L	COIL
L806	EXCELSA39V	COIL
L808	EXCELSA39V	COIL
L809	EXCELD35C	COIL
L810	EXCELSA39V	COIL
L811	EXCELSA39V	COIL
L812	EXCELD35V	COIL
L813	EXCELD35V	COIL
L817	EXCELD35V	COIL
L819	EXCELSA39V	COIL
L843	ELF18D486D	COIL
L845	EXCELSA35T	COIL
L847	EXCELSA35B	COIL
L849	EXCELSA35T	COIL
L854	ELEIE150KA	COIL
L859	EXCELSA35T	COIL
L860	EXCELSA35T	COIL
L861	EXCELSA35T	COIL
L910	EXCELSA35T	COIL
L911	EXCELSA35T	COIL
L912	EXCELSA35T	COIL
L1101	EXCELD35V	COIL
L1103	TLT047K991R	COIL
L1104	EXCELD35V	COIL
L1105	EXCELD35V	COIL
L1106	TLT047K991R	COIL
L1507	TLT018K991R	COIL

Cct Ref	Parts Number	Description
L1508	TLT033K991R	COIL
L1509	EXCELD35V	COIL
L1510	EXCELD35V	COIL
L1511	TLT018K991R	COIL
L1516	EXCELD35V	COIL
L1519	EXCEMT103DTM	COIL
L1523	EXCEMT103DTM	COIL
L1525	EXCEMT103DTM	COIL
L1527	EXCEMT103DTM	COIL
L1528	EXCELD35V	COIL
L1529	EXCELD35V	COIL
L1532	EXCELD35V	COIL
L1533	EXCELD35V	COIL
L1534	EXCELD35V	COIL
L1535	EXCELD35V	COIL
L1536	EXCELD35V	COIL
L1537	TLT100K991R	COIL
L1538	TLT018K991R	COIL
L1539	TLT033K991R	COIL
L1540	TLT018K991R	COIL
L1541	TLT033K991R	COIL
L1542	TLT018K991R	COIL
L1543	TLT033K991R	COIL
L1802	EXCELD35V	COIL
L1803	EXCELD35V	COIL
L1807	EXCELD35V	COIL
L1808	TLT470K991R	COIL
L1809	EXCELD35V	COIL
L1811	EXCELD35V	COIL
L2101	TLT100K991R	COIL
L2102	TLT039K991R	COIL
L2103	TLT100K991R	COIL
L2104	EXCELD35V	COIL
L2106	TLT068K991R	COIL
L2381	EXCELSA35T	COIL
L2382	EXCELSA35T	COIL
L2412	EXCELSA35T	COIL
L2413	EXCELSA35T	COIL
L2505	EXCEMT103DTM	COIL
L2506	EXCEMT103DTM	COIL
L3001	TLT100K991R	COIL
L3205	EXCELD35V	COIL
L3281	EXCELSA35T	COIL
L3282	EXCELSA35T	COIL
L3401	TLT015K991R	COIL
L3402	TLT015K991R	COIL
L3403	TLT015K991R	COIL
L3404	TLT015K991R	COIL
L3405	TLT015K991R	COIL
L3406	TLT015K991R	COIL
L3407	TLT015K991R	COIL
L3408	TLT015K991R	COIL
L3409	TLT100K991R	COIL
L3410	TLT015K991R	COIL
L3411	TLT015K991R	COIL
L3412	TLT015K991R	COIL
L3413	TLT015K991R	COIL
L3801	EXCELD35V	COIL
FILTERS		
L841	ELF18D850C	LINE FILTER
T803	ETQ24K37AY	LINE FILTER
X101	EFCT6504BF	FILTER
X102	EFCT7004BF	CERAMIC FILTER
CRYSTALS		
X601	TSSA010	CRYSTAL
X1101	TSSA121	CRYSTAL

Cct Ref	Parts Number	Description
X1501	TSS2169-B	CRYSTAL
X1801	TSSA009	CRYSTAL
X1802	TSSA025	CRYSTAL
X1803	TSSA024	CRYSTAL
X2101	4730007158	CRYSTAL
RESISTORS		
	ERD25TC0T	CARBON 0.25W 5% 0 Ω
JA1	ERJ6GEY0R00	S.M.CARB 0.1W 5% 0 Ω
JA1	ERJ8GEY0R00	S.M.CARB .125W 5% 0 Ω
JA2	ERJ6GEY0R00	S.M.CARB 0.1W 5% 0 Ω
JA2	ERJ8GEY0R00	S.M.CARB .125W 5% 0 Ω
JA3	ERJ6GEY0R00	S.M.CARB 0.1W 5% 0 Ω
JA3	ERJ8GEY0R00	S.M.CARB .125W 5% 0 Ω
JA4	ERJ6GEY0R00	S.M.CARB 0.1W 5% 0 Ω
JA4	ERJ8GEY0R00	S.M.CARB .125W 5% 0 Ω
JA5	ERJ8GEY0R00	S.M.CARB .125W 5% 0 Ω
JA6	ERJ8GEY0R00	S.M.CARB .125W 5% 0 Ω
JA7	ERJ8GEY0R00	S.M.CARB .125W 5% 0 Ω
JA8	ERJ6GEY0R00	S.M.CARB 0.1W 5% 0 Ω
JA8	ERJ8GEY0R00	S.M.CARB .125W 5% 0 Ω
JA9	ERJ6GEY0R00	S.M.CARB 0.1W 5% 0 Ω
JA10	ERJ6GEY0R00	S.M.CARB 0.1W 5% 0 Ω
JA11	ERJ6GEY0R00	S.M.CARB 0.1W 5% 0 Ω
JA12	ERJ6GEY0R00	S.M.CARB 0.1W 5% 0 Ω
JA13	ERJ8GEY0R00	S.M.CARB .125W 5% 0 Ω
JA14	ERJ8GEY0R00	S.M.CARB .125W 5% 0 Ω
JA15	ERJ8GEY0R00	S.M.CARB .125W 5% 0 Ω
JA18	ERJ6GEY0R00	S.M.CARB 0.1W 5% 0 Ω
JA19	ERJ6GEY0R00	S.M.CARB 0.1W 5% 0 Ω
JA20	ERJ8GEY0R00	S.M.CARB .125W 5% 0 Ω
JA21	ERJ6GEY0R00	S.M.CARB 0.1W 5% 0 Ω
JA23	ERJ6GEY0R00	S.M.CARB 0.1W 5% 0 Ω
JA24	ERJ6GEY0R00	S.M.CARB 0.1W 5% 0 Ω
JA26	ERJ6GEY0R00	S.M.CARB 0.1W 5% 0 Ω
JA27	ERJ6GEY0R00	S.M.CARB 0.1W 5% 0 Ω
JA29	ERJ6GEY0R00	S.M.CARB 0.1W 5% 0 Ω
JA30	ERJ6GEY0R00	S.M.CARB 0.1W 5% 0 Ω
JA31	ERJ6GEY0R00	S.M.CARB 0.1W 5% 0 Ω
JA33	ERJ6GEY0R00	S.M.CARB 0.1W 5% 0 Ω
JA35	ERJ8GEY0R00	S.M.CARB .125W 5% 0 Ω
JA36	ERJ6GEY0R00	S.M.CARB 0.1W 5% 0 Ω
JA37	ERJ6GEY0R00	S.M.CARB 0.1W 5% 0 Ω
JSF005	ERJ6GEY0R00	S.M.CARB 0.1W 5% 0 Ω
JSF021	ERJ6GEY0R00	S.M.CARB 0.1W 5% 0 Ω
JSF020	ERJ6GEY0R00	S.M.CARB 0.1W 5% 0 Ω
JSF019	ERJ6GEY0R00	S.M.CARB 0.1W 5% 0 Ω
JSY03	ERJ6GEY0R00	S.M.CARB 0.1W 5% 0 Ω
JSF017	ERJ6GEY0R00	S.M.CARB 0.1W 5% 0 Ω
JSY04	ERJ6GEY0R00	S.M.CARB 0.1W 5% 0 Ω
JSF013	ERJ6GEY0R00	S.M.CARB 0.1W 5% 0 Ω
JSF010	ERJ6GEY0R00	S.M.CARB 0.1W 5% 0 Ω
JSF009	ERJ6GEY0R00	S.M.CARB 0.1W 5% 0 Ω
JSF022	ERJ6GEY0R00	S.M.CARB 0.1W 5% 0 Ω
JSF006	ERJ6GEY0R00	S.M.CARB 0.1W 5% 0 Ω
JSF018	ERJ6GEY0R00	S.M.CARB 0.1W 5% 0 Ω
JSF001	ERJ6GEY0R00	S.M.CARB 0.1W 5% 0 Ω
JSE044	ERJ6GEY0R00	S.M.CARB 0.1W 5% 0 Ω
JSE033	ERJ6GEY0R00	S.M.CARB 0.1W 5% 0 Ω
JSE026	ERJ6GEY0R00	S.M.CARB 0.1W 5% 0 Ω
JSE025	ERJ6GEY0R00	S.M.CARB 0.1W 5% 0 Ω
JSE024	ERJ6GEY0R00	S.M.CARB 0.1W 5% 0 Ω
JSE011	ERJ6GEY0R00	S.M.CARB 0.1W 5% 0 Ω
JSE009	ERJ6GEY0R00	S.M.CARB 0.1W 5% 0 Ω
JSE004	ERJ6GEY0R00	S.M.CARB 0.1W 5% 0 Ω
JSF007	ERJ6GEY0R00	S.M.CARB 0.1W 5% 0 Ω
JSG2	ERJ6GEY0R00	S.M.CARB 0.1W 5% 0 Ω

Cct Ref	Parts Number	Description				
JSH010	ERJ6GEY0R00	S.M.CARB	0.1W	5%	0	🔌
JSH002	ERJ6GEY0R00	S.M.CARB	0.1W	5%	0	🔌
JSF015	ERJ6GEY0R00	S.M.CARB	0.1W	5%	0	🔌
JSG3	ERJ6GEY0R00	S.M.CARB	0.1W	5%	0	🔌
JSF023	ERJ6GEY0R00	S.M.CARB	0.1W	5%	0	🔌
JSG13	ERJ6GEY0R00	S.M.CARB	0.1W	5%	0	🔌
JSG1	ERJ6GEY0R00	S.M.CARB	0.1W	5%	0	🔌
JSF043	ERJ6GEY0R00	S.M.CARB	0.1W	5%	0	🔌
JSF042	ERJ6GEY0R00	S.M.CARB	0.1W	5%	0	🔌
JSF041	ERJ6GEY0R00	S.M.CARB	0.1W	5%	0	🔌
JSF037	ERJ6GEY0R00	S.M.CARB	0.1W	5%	0	🔌
JSF034	ERJ6GEY0R00	S.M.CARB	0.1W	5%	0	🔌
JSF032	ERJ6GEY0R00	S.M.CARB	0.1W	5%	0	🔌
JSF029	ERJ6GEY0R00	S.M.CARB	0.1W	5%	0	🔌
JSF028	ERJ6GEY0R00	S.M.CARB	0.1W	5%	0	🔌
JSF027	ERJ6GEY0R00	S.M.CARB	0.1W	5%	0	🔌
JSF026	ERJ6GEY0R00	S.M.CARB	0.1W	5%	0	🔌
JSF025	ERJ6GEY0R00	S.M.CARB	0.1W	5%	0	🔌
JSF024	ERJ6GEY0R00	S.M.CARB	0.1W	5%	0	🔌
JSF039	ERJ6GEY0R00	S.M.CARB	0.1W	5%	0	🔌
JSG4	ERJ6GEY0R00	S.M.CARB	0.1W	5%	0	🔌
R001	ERJ6GEYJ223	S.M.CARB	0.1W	5%	22K	🔌
R002	ERJ6GEYJ101	S.M.CARB	0.1W	5%	100	🔌
R003	ERJ6GEYJ393	S.M.CARB	0.1W	5%	39K	🔌
R101	ERJ6GEYJ561	S.M.CARB	0.1W	5%	560	🔌
R102	ERJ6GEYJ101	S.M.CARB	0.1W	5%	100	🔌
R103	ERJ6GEYJ563	S.M.CARB	0.1W	5%	56K	🔌
R104	ERJ6GEYJ471	S.M.CARB	0.1W	5%	470	🔌
R105	ERJ6GEYJ332	S.M.CARB	0.1W	5%	3K3	🔌
R106	ERJ6GEYJ821	S.M.CARB	0.1W	5%	820	🔌
R107	ERJ6GEYJ102	S.M.CARB	0.1W	5%	1K	🔌
R109	ERJ6GEYJ103	S.M.CARB	0.1W	5%	10K	🔌
R110	ERJ6GEYJ222	S.M.CARB	0.1W	5%	2K2	🔌
R111	ERJ6GEYJ331	S.M.CARB	0.1W	5%	330	🔌
R253	ERJ6GEYJ103	S.M.CARB	0.1W	5%	10K	🔌
R255	ERJ6GEYJ103	S.M.CARB	0.1W	5%	10K	🔌
R256	ERJ6GEYJ471	S.M.CARB	0.1W	5%	470	🔌
R260	ERJ6GEYJ103	S.M.CARB	0.1W	5%	10K	🔌
R261	ERJ6GEYJ471	S.M.CARB	0.1W	5%	470	🔌
R262	ERJ6GEYJ103	S.M.CARB	0.1W	5%	10K	🔌
R263	ERJ6GEYJ104	S.M.CARB	0.1W	5%	100K	🔌
R264	ERJ6GEYJ473	S.M.CARB	0.1W	5%	47K	🔌
R265	ERDS1TJ2R2	CARBON	0.5W	5%	2R2	🔌
R266	ERDS1TJ2R2	CARBON	0.5W	5%	2R2	🔌
R269	ERJ6GEYJ273	S.M.CARB	0.1W	5%	27K	🔌
R270	ERJ6GEYJ273	S.M.CARB	0.1W	5%	27K	🔌
R271	ERJ6GEYJ272	S.M.CARB	0.1W	5%	2K7	🔌
R272	ERJ6GEYJ103	S.M.CARB	0.1W	5%	10K	🔌
R273	ERJ6GEYJ331	S.M.CARB	0.1W	5%	330	🔌
R276	ERDS1TJ2R2	CARBON	0.5W	5%	2R2	🔌
R281	ERJ6GEYJ272	S.M.CARB	0.1W	5%	2K7	🔌
R282	ERJ6GEYJ103	S.M.CARB	0.1W	5%	10K	🔌
R283	ERJ6GEYJ471	S.M.CARB	0.1W	5%	470	🔌
R284	ERJ6GEYJ103	S.M.CARB	0.1W	5%	10K	🔌
R285	ERJ6GEYJ101	S.M.CARB	0.1W	5%	100	🔌
R286	ERJ6GEYJ222	S.M.CARB	0.1W	5%	2K2	🔌
R287	ERJ6GEYJ183	S.M.CARB	0.1W	5%	18K	🔌
R288	ERDS1TJ1R0	CARBON	0.5W	5%	1	🔌
R289	ERJ6GEYJ104	S.M.CARB	0.1W	5%	100K	🔌
R290	ERJ6GEYJ104	S.M.CARB	0.1W	5%	100K	🔌
R291	ERJ6GEYJ103	S.M.CARB	0.1W	5%	10K	🔌
R292	ERJ6GEYJ103	S.M.CARB	0.1W	5%	10K	🔌
R293	ERJ6GEYJ104	S.M.CARB	0.1W	5%	100K	🔌
R294	ERJ6GEYJ331	S.M.CARB	0.1W	5%	330	🔌
R351	ERJ6GEYJ911	S.M.CARB	0.1W	5%	910	🔌
R352	ERJ6GEYJ102	S.M.CARB	0.1W	5%	1K	🔌

Cct Ref	Parts Number	Description				
R354	ERO25CKF4122	METAL	0.25W	5%	1K2	🔌 🚩
R355	ERG2FG823H	METAL	2W	5%	82K	🔌 🚩
R357	ERJ6GEYJ822	S.M.CARB	0.1W	5%	8K2	🔌
R360	ERO50PKF8251	METAL	0.5W	5%	8M2	🔌 🚩
R361	ERJ6GEYJ911	S.M.CARB	0.1W	5%	910	🔌
R362	ERJ6GEYJ102	S.M.CARB	0.1W	5%	1K	🔌
R364	ERO25CKF4122	METAL	0.25W	5%	1K2	🔌 🚩
R365	ERG2FG823H	METAL	2W	5%	82K	🔌 🚩
R367	ERJ6GEYJ822	S.M.CARB	0.1W	5%	8K2	🔌
R369	ERJ6GEY0R00	S.M.CARB	0.1W	5%	0	🔌
R371	ERJ6GEYJ911	S.M.CARB	0.1W	5%	910	🔌
R372	ERJ6GEYJ102	S.M.CARB	0.1W	5%	1K	🔌
R374	ERO25CKF4122	METAL	0.25W	5%	1K2	🔌 🚩
R375	ERG2FG823H	METAL	2W	5%	82K	🔌 🚩
R377	ERJ6GEYJ822	S.M.CARB	0.1W	5%	8K2	🔌
R379	ERJ6GEY0R00	S.M.CARB	0.1W	5%	0	🔌
R383	ERJ6GEY0R00	S.M.CARB	0.1W	5%	0	🔌
R401	ERJ6GEYJ272	S.M.CARB	0.1W	5%	2K7	🔌
R402	ERJ6GEYJ682	S.M.CARB	0.1W	5%	6K8	🔌
R403	ERJ6GEYJ102	S.M.CARB	0.1W	5%	1K	🔌
R404	ERJ6GEYJ103	S.M.CARB	0.1W	5%	10K	🔌
R416	ERJ6GEYJ682	S.M.CARB	0.1W	5%	6K8	🔌
R418	ERJ6GEYJ682	S.M.CARB	0.1W	5%	6K8	🔌
R420	ERJ6GEYJ563	S.M.CARB	0.1W	5%	56K	🔌
R421	ERJ6GEYJ224	S.M.CARB	0.1W	5%	220K	🔌
R442	ERJ6GEYJ123	S.M.CARB	0.1W	5%	12K	🔌
R451	ERDS1TJ3R3	CARBON	0.5W	5%	3R3	🔌
R453	ERJ6GEYJ393	S.M.CARB	0.1W	5%	39K	🔌
R454	ERJ6GEYJ123	S.M.CARB	0.1W	5%	12K	🔌
R458	ERJ6GEYJ302	S.M.CARB	0.1W	5%	3K	🔌
R470	ERJ6GEYJ682	S.M.CARB	0.1W	5%	6K8	🔌
R471	ERDS1FJ1R0	CARBON	0.5W	5%	1	🔌 🚩
R504	ERD25TJ271	CARBON	0.25W	5%	270	🔌
R506	ERDS1TJ681	CARBON	0.5W	5%	680	🔌
R507	ERDS1TJ681	CARBON	0.5W	5%	680	🔌
R557	ERDS1TJ683	CARBON	0.5W	5%	68K	🔌
R564	ERDS1TJ394	CARBON	0.5W	5%	390K	🔌
R567	ERG3FJ223	METAL	3W	5%	22K	🔌 🚩
R569	ERDS1TJ120	CARBON	0.5W	5%	12	🔌
R572	ERG3FJ821	METAL	3W	5%	820	🔌 🚩
R574	ERG3FJ151	METAL	3W	5%	150	🔌 🚩
R601	ERJ6GEYJ153	S.M.CARB	0.1W	5%	15K	🔌
R613	ERJ6GEYJ101	S.M.CARB	0.1W	5%	100	🔌
R614	ERJ6GEYJ101	S.M.CARB	0.1W	5%	100	🔌
R615	ERJ6GEYJ101	S.M.CARB	0.1W	5%	100	🔌
R616	ERJ6GEYJ100	S.M.CARB	0.1W	5%	10	🔌
R617	ERJ6GEYJ102	S.M.CARB	0.1W	5%	1K	🔌
R619	ERJ6GEYJ101	S.M.CARB	0.1W	5%	100	🔌
R620	ERJ6GEYJ101	S.M.CARB	0.1W	5%	100	🔌
R622	ERJ6GEYJ393	S.M.CARB	0.1W	5%	39K	🔌
R623	ERJ6GEYJ153	S.M.CARB	0.1W	5%	15K	🔌
R626	ERJ6GEYJ331	S.M.CARB	0.1W	5%	330	🔌
R627	ERJ6GEYJ102	S.M.CARB	0.1W	5%	1K	🔌
R628	ERJ6GEYJ472	S.M.CARB	0.1W	5%	4K7	🔌
R630	ERJ6GEYJ103	S.M.CARB	0.1W	5%	10K	🔌
R631	ERJ6GEYJ105	S.M.CARB	0.1W	5%	1M	🔌
R632	ERJ6GEYJ223	S.M.CARB	0.1W	5%	22K	🔌
R634	ERJ6GEYJ103	S.M.CARB	0.1W	5%	10K	🔌
R635	ERJ6GEYJ101	S.M.CARB	0.1W	5%	100	🔌
R636	ERJ6GEYJ101	S.M.CARB	0.1W	5%	100	🔌
R637	ERJ6GEYJ101	S.M.CARB	0.1W	5%	100	🔌
R638	ERJ6GEYJ101	S.M.CARB	0.1W	5%	100	🔌
R639	ERJ6GEYJ101	S.M.CARB	0.1W	5%	100	🔌
R640	ERJ6GEYJ101	S.M.CARB	0.1W	5%	100	🔌
R641	ERJ6GEYJ101	S.M.CARB	0.1W	5%	100	🔌
R642	ERJ6GEYJ102	S.M.CARB	0.1W	5%	1K	🔌

Cct Ref	Parts Number	Description				
R643	ERJ6GEYJ102	S.M.CARB	0.1W	5%	1K	🔒
R644	ERJ6GEYJ102	S.M.CARB	0.1W	5%	1K	🔒
R645	ERJ6GEYJ102	S.M.CARB	0.1W	5%	1K	🔒
R646	ERJ6GEYJ821	S.M.CARB	0.1W	5%	820	🔒
R647	ERJ6GEYJ101	S.M.CARB	0.1W	5%	100	🔒
R648	ERJ6GEYJ101	S.M.CARB	0.1W	5%	100	🔒
R649	ERJ6GEYJ101	S.M.CARB	0.1W	5%	100	🔒
R650	ERJ6GEYJ101	S.M.CARB	0.1W	5%	100	🔒
R651	ERJ6GEYJ101	S.M.CARB	0.1W	5%	100	🔒
R652	ERJ6GEYJ101	S.M.CARB	0.1W	5%	100	🔒
R653	ERJ6GEYJ101	S.M.CARB	0.1W	5%	100	🔒
R655	ERJ6GEYJ224	S.M.CARB	0.1W	5%	220K	🔒
R657	ERJ6GEYJ750	S.M.CARB	0.1W	5%	75	🔒
R658	ERJ6ENF2212	S.M. CAR	0.1W	5%	220	🔒
R666	ERJ6GEYJ222	S.M.CARB	0.1W	5%	2K2	🔒
R674	ERJ6GEYJ273	S.M.CARB	0.1W	5%	27K	🔒
R675	ERJ6GEYJ562	S.M.CARB	0.1W	5%	5K6	🔒
R676	ERJ6GEYJ103	S.M.CARB	0.1W	5%	10K	🔒
R677	ERJ6GEYJ273	S.M.CARB	0.1W	5%	27K	🔒
R678	ERJ6GEYJ562	S.M.CARB	0.1W	5%	5K6	🔒
R679	ERJ6GEYJ103	S.M.CARB	0.1W	5%	10K	🔒
R681	ERJ6GEYJ103	S.M.CARB	0.1W	5%	10K	🔒
R682	ERJ6GEYJ103	S.M.CARB	0.1W	5%	10K	🔒
R683	ERJ6GEYJ103	S.M.CARB	0.1W	5%	10K	🔒
R684	ERJ6GEYJ101	S.M.CARB	0.1W	5%	100	🔒
R685	ERJ6GEYJ103	S.M.CARB	0.1W	5%	10K	🔒
R686	ERJ6GEYJ102	S.M.CARB	0.1W	5%	1K	🔒
R688	ERJ6ENF3162	S.M. CAR	0.1W	5%	1K6	🔒
R702	ERDS1TJ683	CARBON	0.5W	5%	68K	🔒
R704	ERDS1TJ330	CARBON	0.5W	5%	33	🔒
R807	ERD25TJ104	CARBON	0.25W	5%	100K	🔒
R809	ERF10ZK4R7	WOUND	10W	5%	4R7	🔒 ⚠️
R812	ERD25TJ681	CARBON	0.25W	5%	680	🔒
R814	ERD25TJ392	CARBON	0.25W	5%	3K9	🔒
R815	ERD25TJ100	CARBON	0.25W	5%	10	🔒
R816	ERDS1TJ330	CARBON	0.5W	5%	33	🔒
R820	ERG3FJ223	METAL	3W	5%	22K	🔒 ⚠️
R821	ERG3FJ223	METAL	3W	5%	22K	🔒 ⚠️
R822	ERD25TJ391	CARBON	0.25W	5%	390	🔒
R823	ERX12SJR22	METAL	0.5W	5%	R22	🔒
R824	ERX12SJR22	METAL	0.5W	5%	R22	🔒
R825	ERX12SJR22	METAL	0.5W	5%	R22	🔒
R827	ERDS1FJ121	CARBON	0.5W	5%	120	🔒 ⚠️
R828	ERD25TJ103	CARBON	0.25W	5%	10K	🔒
R829	ERD25TJ221	CARBON	0.25W	5%	220	🔒
R830	ERX12SJR22	METAL	0.5W	5%	R22	🔒
R831	ERD75TAJ825	CARBON	0.75W	5%	8M2	🔒 ⚠️
R832	ERG3FJ331	METAL	3W	5%	330	🔒 ⚠️
R835	ERD25TJ220	CARBON	0.25W	5%	22	🔒
R836	ERD25TJ100	CARBON	0.25W	5%	10	🔒
R837	ERD25TJ183	CARBON	0.25W	5%	18K	🔒
R838	ERD25TJ821	CARBON	0.25W	5%	820	🔒
R841	ERC12ZGK105D	SOLID	0.5W	10%	1M	🔒
R857	ERD25TJ221	CARBON	0.25W	5%	220	🔒
R862	ERD25TJ272	CARBON	0.25W	5%	2K7	🔒
R863	ERG3FJ680H	METAL	3W	5%	68	🔒 ⚠️
R864	ERDS1TJ682	CARBON	0.5W	5%	6K8	🔒
R867	ERD25TJ102	CARBON	0.25W	5%	1K	🔒
R868	ERD25TJ151	CARBON	0.25W	5%	150	🔒
R869	ERD25TJ560	CARBON	0.25W	5%	56	🔒
R873	ERQ2CJP2R4	METAL	2W	5%	2R4	🔒 ⚠️
R877	ERO25CKF1022	METAL	0.25W	1%	10K2	🔒 ⚠️
R878	ERO25CKF1002	METAL	0.25W	1%	10K	🔒 ⚠️
R885	ERD25TJ103	CARBON	0.25W	5%	10K	🔒
R886	ERX3SJR56	METAL	3W	5%	R56	🔒
R888	ERDS1TJ393	CARBON	0.5W	5%	39K	🔒

Cct Ref	Parts Number	Description				
R901	ERJ6GEYJ562	S.M.CARB	0.1W	5%	5K6	🔒
R902	ERJ6GEYJ562	S.M.CARB	0.1W	5%	5K6	🔒
R903	ERJ6GEYJ562	S.M.CARB	0.1W	5%	5K6	🔒
R904	ERJ6GEYJ102	S.M.CARB	0.1W	5%	1K	🔒
R908	ERJ6GEYJ471	S.M.CARB	0.1W	5%	470	🔒
R911	ERD25TJ561	CARBON	0.25W	5%	560	🔒
R913	ERJ6GEYJ183	S.M.CARB	0.1W	5%	18K	🔒
R915	ERJ6GEYJ182	S.M.CARB	0.1W	5%	1K8	🔒
R916	ERJ6GEYJ221	S.M.CARB	0.1W	5%	220	🔒
R917	ERJ6GEYJ121	S.M.CARB	0.1W	5%	120	🔒
R919	ERQ14AJW390	FUSIBLE	0.25W	5%	39	🔒 ⚠️
R920	ERQ14AJW390	FUSIBLE	0.25W	5%	39	🔒 ⚠️
R922	ERD25TJ683	CARBON	0.25W	5%	68K	🔒
R923	ERD25TJ683	CARBON	0.25W	5%	68K	🔒
R925	ERJ6GEY0R00	S.M.CARB	0.1W	5%	0	🔒
R926	ERJ6GEY0R00	S.M.CARB	0.1W	5%	0	🔒
R927	ERD25TJ122	CARBON	0.25W	5%	1K2	🔒
R928	ERD25TJ5R6	CARBON	0.25W	5%	5R6	🔒
R929	ERDS1FYJ471	CARBON	0.5W	5%	470	🔒 ⚠️
R931	ERDS1FYJ390	CARBON	0.5W	5%	39	🔒 ⚠️
R935	ERQ14AJW3R9	FUSIBLE	0.25W	5%	3R9	🔒 ⚠️
R936	ERQ1CJP102	FUSIBLE	1W	5%	1K	🔒 ⚠️
R937	ERQ14AJW100	FUSIBLE	0.25W	5%	10	🔒 ⚠️
R938	ERD25TJ122	CARBON	0.25W	5%	1K2	🔒
R941	ERD25TJ5R6	CARBON	0.25W	5%	5R6	🔒
R1011	ERD25TJ101	CARBON	0.25W	5%	100	🔒
R1012	ERD25TJ101	CARBON	0.25W	5%	100	🔒
R1013	ERD25TJ471	CARBON	0.25W	5%	470	🔒
R1015	ERD25TJ103	CARBON	0.25W	5%	10K	🔒
R1071	ERD25TJ103	CARBON	0.25W	5%	10K	🔒
R1072	ERD25TJ222	CARBON	0.25W	5%	2K2	🔒
R1073	ERD25TJ222	CARBON	0.25W	5%	2K2	🔒
R1074	ERD25TJ332	CARBON	0.25W	5%	3K3	🔒
R1075	ERD25TJ512	CARBON	0.25W	5%	5K1	🔒
R1076	ERD25TJ912	CARBON	0.25W	5%	9K1	🔒
R1101	ERJ6GEYJ101	S.M.CARB	0.1W	5%	100	🔒
R1103	ERJ6GEYJ472	S.M.CARB	0.1W	5%	4K7	🔒
R1104	ERJ6GEYJ101	S.M.CARB	0.1W	5%	100	🔒
R1105	ERJ6GEYJ101	S.M.CARB	0.1W	5%	100	🔒
R1106	ERJ6GEYJ472	S.M.CARB	0.1W	5%	4K7	🔒
R1107	ERJ6GEYJ101	S.M.CARB	0.1W	5%	100	🔒
R1108	ERJ6GEYJ472	S.M.CARB	0.1W	5%	4K7	🔒
R1109	ERJ6GEYJ101	S.M.CARB	0.1W	5%	100	🔒
R1110	ERJ6GEYJ101	S.M.CARB	0.1W	5%	100	🔒
R1111	ERJ6GEYJ101	S.M.CARB	0.1W	5%	100	🔒
R1113	ERJ6GEYJ101	S.M.CARB	0.1W	5%	100	🔒
R1114	ERJ6GEYJ101	S.M.CARB	0.1W	5%	100	🔒
R1116	ERJ6GEYJ101	S.M.CARB	0.1W	5%	100	🔒
R1117	ERJ6GEYJ332	S.M.CARB	0.1W	5%	3K3	🔒
R1118	ERJ6GEYJ332	S.M.CARB	0.1W	5%	3K3	🔒
R1119	ERJ6GEYJ332	S.M.CARB	0.1W	5%	3K3	🔒
R1120	ERJ6GEYJ332	S.M.CARB	0.1W	5%	3K3	🔒
R1121	ERJ6GEYJ472	S.M.CARB	0.1W	5%	4K7	🔒
R1122	ERJ6GEYJ472	S.M.CARB	0.1W	5%	4K7	🔒
R1123	ERJ6GEYJ823	S.M.CARB	0.1W	5%	82K	🔒
R1124	ERJ6GEYJ101	S.M.CARB	0.1W	5%	100	🔒
R1125	ERJ6GEYJ101	S.M.CARB	0.1W	5%	100	🔒
R1126	ERJ6GEYJ101	S.M.CARB	0.1W	5%	100	🔒
R1127	ERJ6GEYJ101	S.M.CARB	0.1W	5%	100	🔒
R1128	ERJ6GEYJ472	S.M.CARB	0.1W	5%	4K7	🔒
R1129	ERJ6GEYJ472	S.M.CARB	0.1W	5%	4K7	🔒
R1130	ERJ6GEYJ104	S.M.CARB	0.1W	5%	100K	🔒
R1131	ERJ6GEYJ101	S.M.CARB	0.1W	5%	100	🔒
R1132	ERJ6GEYJ101	S.M.CARB	0.1W	5%	100	🔒
R1133	ERJ6GEYJ101	S.M.CARB	0.1W	5%	100	🔒
R1133	ERJ6GEYJ101	S.M.CARB	0.1W	5%	100	🔒
R1134	ERJ6GEYJ101	S.M.CARB	0.1W	5%	100	🔒

Cct Ref	Parts Number	Description				
R1135	ERJ6GEYJ225	S.M.CARB	0.1W	5%	2M2	☐
R1138	ERJ6GEYJ273	S.M.CARB	0.1W	5%	27K	☐
R1139	ERJ6GEYJ472	S.M.CARB	0.1W	5%	4K7	☐
R1140	ERJ6GEYJ392	S.M.CARB	0.1W	5%	3K9	☐
R1141	ERJ6GEYJ103	S.M.CARB	0.1W	5%	10K	☐
R1142	ERJ6GEYJ103	S.M.CARB	0.1W	5%	10K	☐
R1143	ERJ6GEYJ101	S.M.CARB	0.1W	5%	100	☐
R1144	ERJ6GEYJ473	S.M.CARB	0.1W	5%	47K	☐
R1145	ERJ6GEYJ472	S.M.CARB	0.1W	5%	4K7	☐
R1146	ERJ6GEYJ101	S.M.CARB	0.1W	5%	100	☐
R1147	ERJ6GEYJ223	S.M.CARB	0.1W	5%	22K	☐
R1148	ERJ6GEYJ104	S.M.CARB	0.1W	5%	100K	☐
R1149	ERJ6GEYJ104	S.M.CARB	0.1W	5%	100K	☐
R1150	ERJ6GEYJ104	S.M.CARB	0.1W	5%	100K	☐
R1151	ERJ6GEYJ103	S.M.CARB	0.1W	5%	10K	☐
R1152	ERJ6GEYJ224	S.M.CARB	0.1W	5%	220K	☐
R1153	ERJ6GEYJ273	S.M.CARB	0.1W	5%	27K	☐
R1154	ERJ6GEYJ221	S.M.CARB	0.1W	5%	220	☐
R1155	ERJ6GEYJ474	S.M.CARB	0.1W	5%	470K	☐
R1156	ERJ6GEY0R00	S.M.CARB	0.1W	5%	0	☐
R1157	ERJ6GEYJ100	S.M.CARB	0.1W	5%	10	☐
R1158	ERJ6GEYJ472	S.M.CARB	0.1W	5%	4K7	☐
R1160	ERJ6GEY0R00	S.M.CARB	0.1W	5%	0	☐
R1161	ERJ6GEYJ392	S.M.CARB	0.1W	5%	3K9	☐
R1162	ERJ6GEYJ102	S.M.CARB	0.1W	5%	1K	☐
R1163	ERJ6GEYJ103	S.M.CARB	0.1W	5%	10K	☐
R1164	ERJ6GEYJ103	S.M.CARB	0.1W	5%	10K	☐
R1165	ERJ6GEYJ103	S.M.CARB	0.1W	5%	10K	☐
R1166	ERJ6GEYJ683	S.M.CARB	0.1W	5%	68K	☐
R1167	ERJ6GEYJ103	S.M.CARB	0.1W	5%	10K	☐
R1168	ERJ6GEYJ103	S.M.CARB	0.1W	5%	10K	☐
R1169	ERJ6GEYJ103	S.M.CARB	0.1W	5%	10K	☐
R1170	ERJ6GEYJ472	S.M.CARB	0.1W	5%	4K7	☐
R1171	ERJ6GEYJ472	S.M.CARB	0.1W	5%	4K7	☐
R1172	ERJ6GEYJ821	S.M.CARB	0.1W	5%	820	☐
R1173	ERJ6GEYJ681	S.M.CARB	0.1W	5%	680	☐
R1174	ERJ6GEYJ681	S.M.CARB	0.1W	5%	680	☐
R1175	ERJ6GEYJ101	S.M.CARB	0.1W	5%	100	☐
R1176	ERJ6GEYJ101	S.M.CARB	0.1W	5%	100	☐
R1177	ERJ6GEYJ103	S.M.CARB	0.1W	5%	10K	☐
R1178	ERJ6GEYJ103	S.M.CARB	0.1W	5%	10K	☐
R1179	ERJ6GEYJ101	S.M.CARB	0.1W	5%	100	☐
R1180	ERJ6GEYJ472	S.M.CARB	0.1W	5%	4K7	☐
R1181	ERJ6GEYJ101	S.M.CARB	0.1W	5%	100	☐
R1182	ERJ6GEYJ472	S.M.CARB	0.1W	5%	4K7	☐
R1183	ERJ6GEYJ472	S.M.CARB	0.1W	5%	4K7	☐
R1184	ERJ6GEYJ101	S.M.CARB	0.1W	5%	100	☐
R1186	ERJ6GEYJ103	S.M.CARB	0.1W	5%	10K	☐
R1187	ERJ6GEYJ103	S.M.CARB	0.1W	5%	10K	☐
R1188	ERJ6GEYJ472	S.M.CARB	0.1W	5%	4K7	☐
R1189	ERJ6GEYJ101	S.M.CARB	0.1W	5%	100	☐
R1190	ERJ6GEYJ472	S.M.CARB	0.1W	5%	4K7	☐
R1194	ERJ6GEYJ681	S.M.CARB	0.1W	5%	680	☐
R1195	ERJ6GEYJ103	S.M.CARB	0.1W	5%	10K	☐
R1200	ERJ6GEYJ472	S.M.CARB	0.1W	5%	4K7	☐
R1237	ERJ6GEY0R00	S.M.CARB	0.1W	5%	0	☐
R1238	ERJ6GEYJ102	S.M.CARB	0.1W	5%	1K	☐
R1239	ERJ6GEYJ560	S.M.CARB	0.1W	5%	56	☐
R1501	ERJ6GEY0R00	S.M.CARB	0.1W	5%	0	☐
R1502	ERJ6GEYJ151	S.M.CARB	0.1W	5%	150	☐
R1503	ERJ6GEYJ332	S.M.CARB	0.1W	5%	3K3	☐
R1504	ERJ6GEYJ151	S.M.CARB	0.1W	5%	150	☐
R1505	ERJ6GEYJ471	S.M.CARB	0.1W	5%	470	☐
R1506	ERJ6GEYJ271	S.M.CARB	0.1W	5%	270	☐
R1507	ERJ6GEYJ102	S.M.CARB	0.1W	5%	1K	☐
R1508	ERJ6GEYJ471	S.M.CARB	0.1W	5%	470	☐

Cct Ref	Parts Number	Description				
R1509	ERJ6GEYJ471	S.M.CARB	0.1W	5%	470	☐
R1510	ERJ6GEYJ8R2	S.M. CAR	0.1W	5%	8R2	☐
R1511	ERJ6GEYJ101	S.M.CARB	0.1W	5%	100	☐
R1513	ERJ6GEYJ101	S.M.CARB	0.1W	5%	100	☐
R1514	ERJ6GEYJ180	S.M.CARB	0.1W	5%	18	☐
R1515	ERJ6GEYJ101	S.M.CARB	0.1W	5%	100	☐
R1517	ERJ6GEYJ180	S.M.CARB	0.1W	5%	18	☐
R1518	ERJ6GEYJ180	S.M.CARB	0.1W	5%	18	☐
R1519	ERJ6GEYJ561	S.M.CARB	0.1W	5%	560	☐
R1520	ERJ6GEYJ471	S.M.CARB	0.1W	5%	470	☐
R1521	ERJ6GEYJ820	S.M.CARB	0.1W	5%	82	☐
R1522	ERJ6GEYJ103	S.M.CARB	0.1W	5%	10K	☐
R1523	ERJ6GEYJ390	S.M.CARB	0.1W	5%	39	☐
R1524	ERJ6GEYJ560	S.M.CARB	0.1W	5%	56	☐
R1525	ERJ6GEYJ271	S.M.CARB	0.1W	5%	270	☐
R1526	ERJ6GEY0R00	S.M.CARB	0.1W	5%	0	☐
R1527	ERJ6GEYJ100	S.M.CARB	0.1W	5%	10	☐
R1528	ERJ6GEYJ151	S.M.CARB	0.1W	5%	150	☐
R1530	ERJ6GEYJ560	S.M.CARB	0.1W	5%	56	☐
R1531	ERJ6GEYJ151	S.M.CARB	0.1W	5%	150	☐
R1532	ERJ6GEYJ151	S.M.CARB	0.1W	5%	150	☐
R1533	ERJ6GEYJ181	S.M.CARB	0.1W	5%	180	☐
R1534	ERJ6GEYJ272	S.M.CARB	0.1W	5%	2K7	☐
R1535	ERJ6GEYJ103	S.M.CARB	0.1W	5%	10K	☐
R1536	ERJ6GEYJ470	S.M.CARB	0.1W	5%	47	☐
R1537	ERJ6GEYJ103	S.M.CARB	0.1W	5%	10K	☐
R1538	ERJ6GEYJ181	S.M.CARB	0.1W	5%	180	☐
R1540	ERJ6GEYJ102	S.M.CARB	0.1W	5%	1K	☐
R1541	ERJ6GEYJ102	S.M.CARB	0.1W	5%	1K	☐
R1542	ERJ6GEYJ151	S.M.CARB	0.1W	5%	150	☐
R1543	ERJ6GEYJ103	S.M.CARB	0.1W	5%	10K	☐
R1544	ERJ6GEYJ561	S.M.CARB	0.1W	5%	560	☐
R1545	ERJ6ENF3600	S.M. CAR	0.1W	5%	36	☐
R1546	ERJ6GEYJ561	S.M.CARB	0.1W	5%	560	☐
R1547	ERJ6GEYJ103	S.M.CARB	0.1W	5%	10K	☐
R1548	ERJ6GEYJ221	S.M.CARB	0.1W	5%	220	☐
R1550	ERJ6GEYJ103	S.M.CARB	0.1W	5%	10K	☐
R1551	ERJ6GEYJ271	S.M.CARB	0.1W	5%	270	☐
R1552	ERJ6GEYJ103	S.M.CARB	0.1W	5%	10K	☐
R1553	ERJ6GEYJ750	S.M.CARB	0.1W	5%	75	☐
R1554	ERJ6GEYJ101	S.M.CARB	0.1W	5%	100	☐
R1555	ERJ6GEYJ101	S.M.CARB	0.1W	5%	100	☐
R1556	ERJ6GEYJ101	S.M.CARB	0.1W	5%	100	☐
R1559	ERJ6ENF2200	S.M. CAR	0.1W	5%	22	☐
R1560	ERJ6GEYJ560	S.M.CARB	0.1W	5%	56	☐
R1561	ERJ6GEY0R00	S.M.CARB	0.1W	5%	0	☐
R1562	ERJ6ENF4750	S.M. CAR	0.1W	5%	75	☐
R1563	ERJ6GEYJ271	S.M.CARB	0.1W	5%	270	☐
R1564	ERJ6ENF2200	S.M. CAR	0.1W	5%	22	☐
R1565	ERJ6GEYJ820	S.M.CARB	0.1W	5%	82	☐
R1566	ERJ6GEYJ331	S.M.CARB	0.1W	5%	330	☐
R1567	ERJ6ENF1500	S.M. CAR	0.1W	5%	15	☐
R1568	ERJ6ENF1500	S.M. CAR	0.1W	5%	15	☐
R1569	ERJ6ENF1500	S.M. CAR	0.1W	5%	15	☐
R1570	ERJ6ENF2701	S.M.CARB	0.1W	5%	27	☐
R1571	ERJ6GEYJ103	S.M.CARB	0.1W	5%	10K	☐
R1572	ERJ6GEYJ103	S.M.CARB	0.1W	5%	10K	☐
R1573	ERJ6ENF1500	S.M. CAR	0.1W	5%	15	☐
R1574	ERJ6GEYJ560	S.M.CARB	0.1W	5%	56	☐
R1575	ERJ6GEYJ102	S.M.CARB	0.1W	5%	1K	☐
R1576	ERJ6GEYJ102	S.M.CARB	0.1W	5%	1K	☐
R1577	ERJ6GEYJ102	S.M.CARB	0.1W	5%	1K	☐
R1578	ERJ6GEYJ301	S.M.CARB	0.1W	5%	300	☐
R1579	ERJ6GEYJ431	S.M.CARB	0.1W	5%	430	☐
R1580	ERJ6GEYJ511	S.M.CARB	0.1W	5%	510	☐
R1581	ERJ6GEYJ151	S.M.CARB	0.1W	5%	150	☐

Cct Ref	Parts Number	Description				
R1582	ERJ6GEYJ103	S.M.CARB	0.1W	5%	10K	Ω
R1583	ERJ6GEYJ561	S.M.CARB	0.1W	5%	560	Ω
R1584	ERJ6GEYJ561	S.M.CARB	0.1W	5%	560	Ω
R1585	ERJ6GEYJ103	S.M.CARB	0.1W	5%	10K	Ω
R1586	ERJ6GEY0R00	S.M.CARB	0.1W	5%	0	Ω
R1587	ERJ6GEY0R00	S.M.CARB	0.1W	5%	0	Ω
R1588	ERJ6GEYJ221	S.M.CARB	0.1W	5%	220	Ω
R1589	ERJ6GEYJ152	S.M.CARB	0.1W	5%	1K5	Ω
R1590	ERJ6GEYJ101	S.M.CARB	0.1W	5%	100	Ω
R1591	ERJ6GEYJ103	S.M.CARB	0.1W	5%	10K	Ω
R1592	ERJ6GEYJ101	S.M.CARB	0.1W	5%	100	Ω
R1593	ERJ6GEYJ101	S.M.CARB	0.1W	5%	100	Ω
R1594	ERJ6GEYJ101	S.M.CARB	0.1W	5%	100	Ω
R1595	ERJ6GEYJ101	S.M.CARB	0.1W	5%	100	Ω
R1598	ERJ6GEYJ101	S.M.CARB	0.1W	5%	100	Ω
R1599	ERJ6GEYJ101	S.M.CARB	0.1W	5%	100	Ω
R1600	ERJ6GEYJ103	S.M.CARB	0.1W	5%	10K	Ω
R1603	ERJ6GEYJ101	S.M.CARB	0.1W	5%	100	Ω
R1604	ERJ6GEYJ820	S.M.CARB	0.1W	5%	82	Ω
R1605	ERJ6GEYJ183	S.M.CARB	0.1W	5%	18K	Ω
R1606	ERJ6GEYJ273	S.M.CARB	0.1W	5%	27K	Ω
R1607	ERJ6GEYJ101	S.M.CARB	0.1W	5%	100	Ω
R1609	ERJ6GEYJ103	S.M.CARB	0.1W	5%	10K	Ω
R1610	ERJ6GEYJ101	S.M.CARB	0.1W	5%	100	Ω
R1611	ERJ6GEYJ101	S.M.CARB	0.1W	5%	100	Ω
R1613	ERJ6GEYJ102	S.M.CARB	0.1W	5%	1K	Ω
R1614	ERJ6GEY0R00	S.M.CARB	0.1W	5%	0	Ω
R1615	ERJ6GEY0R00	S.M.CARB	0.1W	5%	0	Ω
R1616	ERJ6GEYJ101	S.M.CARB	0.1W	5%	100	Ω
R1617	ERJ6ENF1100	S.M. CAR	0.1W	5%	10	Ω
R1618	ERJ6GEYJ103	S.M.CARB	0.1W	5%	10K	Ω
R1619	ERJ6GEYJ103	S.M.CARB	0.1W	5%	10K	Ω
R1620	ERJ6GEYJ331	S.M.CARB	0.1W	5%	330	Ω
R1621	ERJ6GEYJ471	S.M.CARB	0.1W	5%	470	Ω
R1622	ERJ6GEYJ102	S.M.CARB	0.1W	5%	1K	Ω
R1623	ERJ6GEYJ471	S.M.CARB	0.1W	5%	470	Ω
R1624	ERJ6GEYJ333	S.M.CARB	0.1W	5%	33K	Ω
R1625	ERJ6GEYJ221	S.M.CARB	0.1W	5%	220	Ω
R1626	ERJ6GEYJ332	S.M.CARB	0.1W	5%	3K3	Ω
R1627	ERJ6GEYJ100	S.M.CARB	0.1W	5%	10	Ω
R1628	ERJ6GEY0R00	S.M.CARB	0.1W	5%	0	Ω
R1629	ERJ6GEYJ121	S.M.CARB	0.1W	5%	120	Ω
R1630	ERJ6GEYJ103	S.M.CARB	0.1W	5%	10K	Ω
R1631	ERJ6ENF1500	S.M. CAR	0.1W	5%	15	Ω
R1632	ERJ6GEY0R00	S.M.CARB	0.1W	5%	0	Ω
R1633	ERJ6GEY0R00	S.M.CARB	0.1W	5%	0	Ω
R1634	ERJ6GEYJ101	S.M.CARB	0.1W	5%	100	Ω
R1635	ERJ6GEYJ271	S.M.CARB	0.1W	5%	270	Ω
R1636	ERJ6GEYJ101	S.M.CARB	0.1W	5%	100	Ω
R1637	ERJ6GEYJ271	S.M.CARB	0.1W	5%	270	Ω
R1639	ERJ6GEYJ331	S.M.CARB	0.1W	5%	330	Ω
R1640	ERJ6GEY0R00	S.M.CARB	0.1W	5%	0	Ω
R1641	ERJ6GEYJ473	S.M.CARB	0.1W	5%	47K	Ω
R1642	ERJ6GEYJ183	S.M.CARB	0.1W	5%	18K	Ω
R1643	ERJ6GEYJ473	S.M.CARB	0.1W	5%	47K	Ω
R1644	ERJ6GEYJ183	S.M.CARB	0.1W	5%	18K	Ω
R1645	ERJ6GEYJ473	S.M.CARB	0.1W	5%	47K	Ω
R1646	ERJ6GEYJ183	S.M.CARB	0.1W	5%	18K	Ω
R1660	ERJ6GEYJ103	S.M.CARB	0.1W	5%	10K	Ω
R1661	ERJ6GEYJ471	S.M.CARB	0.1W	5%	470	Ω
R1662	ERJ6GEYJ223	S.M.CARB	0.1W	5%	22K	Ω
R1663	ERJ6GEYJ331	S.M.CARB	0.1W	5%	330	Ω
R1664	ERJ6GEYJ103	S.M.CARB	0.1W	5%	10K	Ω
R1665	ERJ6GEYJ471	S.M.CARB	0.1W	5%	470	Ω
R1666	ERJ6GEYJ223	S.M.CARB	0.1W	5%	22K	Ω
R1667	ERJ6GEYJ331	S.M.CARB	0.1W	5%	330	Ω

Cct Ref	Parts Number	Description				
R1668	ERJ6GEYJ103	S.M.CARB	0.1W	5%	10K	Ω
R1669	ERJ6GEYJ471	S.M.CARB	0.1W	5%	470	Ω
R1670	ERJ6GEYJ223	S.M.CARB	0.1W	5%	22K	Ω
R1671	ERJ6GEYJ331	S.M.CARB	0.1W	5%	330	Ω
R1672	ERJ6GEYJ471	S.M.CARB	0.1W	5%	470	Ω
R1673	ERJ6GEY0R00	S.M.CARB	0.1W	5%	0	Ω
R1674	ERJ6GEY0R00	S.M.CARB	0.1W	5%	0	Ω
R1675	ERJ6GEY0R00	S.M.CARB	0.1W	5%	0	Ω
R1676	ERJ6GEYJ560	S.M.CARB	0.1W	5%	56	Ω
R1677	ERJ6ENF6800	S.M. CAR	0.1W	5%	80	Ω
R1678	ERJ6ENF1500	S.M. CAR	0.1W	5%	15	Ω
R1679	ERJ6ENF1500	S.M. CAR	0.1W	5%	15	Ω
R1680	ERJ6GEYJ271	S.M.CARB	0.1W	5%	270	Ω
R1681	ERJ6GEYJ271	S.M.CARB	0.1W	5%	270	Ω
R1682	ERJ6GEYJ271	S.M.CARB	0.1W	5%	270	Ω
R1683	ERJ6GEYJ271	S.M.CARB	0.1W	5%	270	Ω
R1684	ERJ6GEYJ271	S.M.CARB	0.1W	5%	270	Ω
R1685	ERQ14AJ100	FUSIBLE	0.25W	5%	10	Ω
R1686	ERJ6GEYJ103	S.M.CARB	0.1W	5%	10K	Ω
R1687	ERJ6GEYJ103	S.M.CARB	0.1W	5%	10K	Ω
R1688	ERJ6GEYJ331	S.M.CARB	0.1W	5%	330	Ω
R1690	ERJ6GEYJ750	S.M.CARB	0.1W	5%	75	Ω
R1691	ERJ6GEYJ750	S.M.CARB	0.1W	5%	75	Ω
R1692	ERJ6GEYJ750	S.M.CARB	0.1W	5%	75	Ω
R1801	ERJ6GEYJ101	S.M.CARB	0.1W	5%	100	Ω
R1802	ERJ6GEYJ471	S.M.CARB	0.1W	5%	470	Ω
R1803	ERJ6GEYJ101	S.M.CARB	0.1W	5%	100	Ω
R1804	ERJ6GEYJ431	S.M.CARB	0.1W	5%	430	Ω
R1805	ERJ6GEYJ682	S.M.CARB	0.1W	5%	6K8	Ω
R1806	ERJ6GEYJ101	S.M.CARB	0.1W	5%	100	Ω
R1807	ERJ6GEYJ471	S.M.CARB	0.1W	5%	470	Ω
R1808	ERJ6GEYJ101	S.M.CARB	0.1W	5%	100	Ω
R1810	ERJ6GEYJ102	S.M.CARB	0.1W	5%	1K	Ω
R1811	ERJ6GEYJ102	S.M.CARB	0.1W	5%	1K	Ω
R1813	ERJ6GEY0R00	S.M.CARB	0.1W	5%	0	Ω
R1814	ERJ6GEYJ471	S.M.CARB	0.1W	5%	470	Ω
R1815	ERJ6GEYJ101	S.M.CARB	0.1W	5%	100	Ω
R1816	ERJ6GEYJ101	S.M.CARB	0.1W	5%	100	Ω
R1817	ERJ6GEYJ391	S.M.CARB	0.1W	5%	390	Ω
R1818	ERJ6GEY0R00	S.M.CARB	0.1W	5%	0	Ω
R1819	ERJ6GEY0R00	S.M.CARB	0.1W	5%	0	Ω
R1820	ERJ6GEYJ471	S.M.CARB	0.1W	5%	470	Ω
R1821	ERJ6GEYJ471	S.M.CARB	0.1W	5%	470	Ω
R1823	ERJ6GEYJ103	S.M.CARB	0.1W	5%	10K	Ω
R1824	ERJ6GEY0R00	S.M.CARB	0.1W	5%	0	Ω
R1825	ERJ6GEYJ471	S.M.CARB	0.1W	5%	470	Ω
R1826	ERJ6GEYJ221	S.M.CARB	0.1W	5%	220	Ω
R1827	ERJ6GEYJ132	S.M. CAR	0.1W	5%	1K2	Ω
R1828	ERJ6GEYJ391	S.M.CARB	0.1W	5%	390	Ω
R1829	ERJ6GEYJ101	S.M.CARB	0.1W	5%	100	Ω
R1830	ERJ6GEYJ101	S.M.CARB	0.1W	5%	100	Ω
R1834	ERJ6GEYJ101	S.M.CARB	0.1W	5%	100	Ω
R1835	ERJ6GEYJ823	S.M.CARB	0.1W	5%	82K	Ω
R1839	ERJ6GEYJ225	S.M.CARB	0.1W	5%	2M2	Ω
R1840	ERJ6GEY0R00	S.M.CARB	0.1W	5%	0	Ω
R1841	ERJ6GEYJ153	S.M.CARB	0.1W	5%	15K	Ω
R1842	ERJ6GEYJ151	S.M.CARB	0.1W	5%	150	Ω
R1845	ERJ6GEYJ221	S.M.CARB	0.1W	5%	220	Ω
R1846	ERJ6GEYJ221	S.M.CARB	0.1W	5%	220	Ω
R1847	ERJ6GEYJ221	S.M.CARB	0.1W	5%	220	Ω
R1848	ERJ6GEYJ471	S.M.CARB	0.1W	5%	470	Ω
R1849	ERJ6GEYJ471	S.M.CARB	0.1W	5%	470	Ω
R1850	ERJ6GEYJ471	S.M.CARB	0.1W	5%	470	Ω
R1851	ERJ6GEYJ471	S.M.CARB	0.1W	5%	470	Ω
R1852	ERJ6GEYJ471	S.M.CARB	0.1W	5%	470	Ω
R1853	ERJ6GEYJ471	S.M.CARB	0.1W	5%	470	Ω

Cct Ref	Parts Number	Description				
R1854	ERJ6GEYJ151	S.M.CARB	0.1W	5%	150	Ω
R1855	ERJ6GEYJ911	S.M.CARB	0.1W	5%	910	Ω
R1856	ERJ6GEYJ223	S.M.CARB	0.1W	5%	22K	Ω
R1857	ERC14GJ206D	SOLID	14W	5%	20M	Ω
R1858	ERC14GJ206D	SOLID	14W	5%	20M	Ω
R2101	ERJ6GEYJ101	S.M.CARB	0.1W	5%	100	Ω
R2102	ERJ6GEYJ101	S.M.CARB	0.1W	5%	100	Ω
R2103	ERJ6GEY0R00	S.M.CARB	0.1W	5%	0	Ω
R2104	ERJ6GEY0R00	S.M.CARB	0.1W	5%	0	Ω
R2105	ERJ6GEYJ102	S.M.CARB	0.1W	5%	1K	Ω
R2106	ERJ6GEYJ101	S.M.CARB	0.1W	5%	100	Ω
R2107	ERJ6GEYJ101	S.M.CARB	0.1W	5%	100	Ω
R2108	ERJ6GEYJ103	S.M.CARB	0.1W	5%	10K	Ω
R2109	ERJ6GEYJ472	S.M.CARB	0.1W	5%	4K7	Ω
R2110	ERJ6GEYJ101	S.M.CARB	0.1W	5%	100	Ω
R2111	ERJ6GEYJ471	S.M.CARB	0.1W	5%	470	Ω
R2112	ERJ6GEYJ472	S.M.CARB	0.1W	5%	4K7	Ω
R2114	ERJ6GEYJ101	S.M.CARB	0.1W	5%	100	Ω
R2117	ERJ6GEYJ222	S.M.CARB	0.1W	5%	2K2	Ω
R2118	ERJ6GEYJ471	S.M.CARB	0.1W	5%	470	Ω
R2120	ERJ6GEYJ471	S.M.CARB	0.1W	5%	470	Ω
R2121	ERJ6GEYJ222	S.M.CARB	0.1W	5%	2K2	Ω
R2122	ERJ6GEYJ471	S.M.CARB	0.1W	5%	470	Ω
R2123	ERJ6GEYJ222	S.M.CARB	0.1W	5%	2K2	Ω
R2124	ERJ6GEYJ101	S.M.CARB	0.1W	5%	100	Ω
R2125	ERJ6GEYJ103	S.M.CARB	0.1W	5%	10K	Ω
R2301	ERJ6GEYJ104	S.M.CARB	0.1W	5%	100K	Ω
R2302	ERJ6GEYJ103	S.M.CARB	0.1W	5%	10K	Ω
R2303	ERJ6GEYJ104	S.M.CARB	0.1W	5%	100K	Ω
R2304	ERJ6GEYJ471	S.M.CARB	0.1W	5%	470	Ω
R2307	ERJ6GEYJ471	S.M.CARB	0.1W	5%	470	Ω
R2308	ERJ6GEYJ103	S.M.CARB	0.1W	5%	10K	Ω
R2312	ERJ6GEYJ272	S.M.CARB	0.1W	5%	2K7	Ω
R2314	ERJ6GEYJ471	S.M.CARB	0.1W	5%	470	Ω
R2315	ERJ6GEYJ471	S.M.CARB	0.1W	5%	470	Ω
R2316	ERJ6GEYJ222	S.M.CARB	0.1W	5%	2K2	Ω
R2318	ERJ6GEYJ331	S.M.CARB	0.1W	5%	330	Ω
R2319	ERJ6GEYJ222	S.M.CARB	0.1W	5%	2K2	Ω
R2320	ERJ6GEYJ101	S.M.CARB	0.1W	5%	100	Ω
R2321	ERJ6GEYJ101	S.M.CARB	0.1W	5%	100	Ω
R2351	ERJ6GEYJ102	S.M.CARB	0.1W	5%	1K	Ω
R2352	ERJ6GEYJ102	S.M.CARB	0.1W	5%	1K	Ω
R2353	ERJ6GEYJ103	S.M.CARB	0.1W	5%	10K	Ω
R2354	ERJ6GEYJ103	S.M.CARB	0.1W	5%	10K	Ω
R2355	ERJ6GEYJ103	S.M.CARB	0.1W	5%	10K	Ω
R2356	ERJ6GEYJ103	S.M.CARB	0.1W	5%	10K	Ω
R2357	ERJ6GEYJ562	S.M.CARB	0.1W	5%	5K6	Ω
R2358	ERJ6GEYJ562	S.M.CARB	0.1W	5%	5K6	Ω
R2359	ERJ6GEYJ393	S.M.CARB	0.1W	5%	39K	Ω
R2361	ERJ6GEYJ223	S.M.CARB	0.1W	5%	22K	Ω
R2362	ERJ6GEYJ103	S.M.CARB	0.1W	5%	10K	Ω
R2363	ERJ6GEYJ103	S.M.CARB	0.1W	5%	10K	Ω
R2364	ERD25TJ101	CARBON	0.25W	5%	100	Ω
R2365	ERJ6GEYJ102	S.M.CARB	0.1W	5%	1K	Ω
R2368	ERJ6GEYJ222	S.M.CARB	0.1W	5%	2K2	Ω
R2369	ERJ6GEYJ222	S.M.CARB	0.1W	5%	2K2	Ω
R2370	ERJ6GEYJ103	S.M.CARB	0.1W	5%	10K	Ω
R2371	ERJ6GEYJ103	S.M.CARB	0.1W	5%	10K	Ω
R2372	ERJ6GEYJ562	S.M.CARB	0.1W	5%	5K6	Ω
R2373	ERJ6GEYJ562	S.M.CARB	0.1W	5%	5K6	Ω
R2376	ERJ6GEYJ103	S.M.CARB	0.1W	5%	10K	Ω
R2377	ERJ6GEYJ103	S.M.CARB	0.1W	5%	10K	Ω
R2459	ERJ6GEY0R00	S.M.CARB	0.1W	5%	0	Ω
R2460	ERJ6GEY0R00	S.M.CARB	0.1W	5%	0	Ω
R2474	ERJ6GEYJ101	S.M.CARB	0.1W	5%	100	Ω
R2475	ERJ6GEYJ101	S.M.CARB	0.1W	5%	100	Ω

Cct Ref	Parts Number	Description				
R3004	ERJ6GEYJ470	S.M.CARB	0.1W	5%	47	Ω
R3005	ERJ6GEYJ104	S.M.CARB	0.1W	5%	100K	Ω
R3006	ERJ6GEYJ221	S.M.CARB	0.1W	5%	220	Ω
R3007	ERJ6GEY0R00	S.M.CARB	0.1W	5%	0	Ω
R3008	ERJ6GEYJ470	S.M.CARB	0.1W	5%	47	Ω
R3009	ERJ6GEYJ470	S.M.CARB	0.1W	5%	47	Ω
R3010	ERJ6GEYJ104	S.M.CARB	0.1W	5%	100K	Ω
R3011	ERJ6GEYJ104	S.M.CARB	0.1W	5%	100K	Ω
R3012	ERJ6GEYJ104	S.M.CARB	0.1W	5%	100K	Ω
R3013	ERJ6GEYJ101	S.M.CARB	0.1W	5%	100	Ω
R3014	ERJ6GEYJ101	S.M.CARB	0.1W	5%	100	Ω
R3015	ERJ6GEYJ470	S.M.CARB	0.1W	5%	47	Ω
R3016	ERJ6GEYJ121	S.M.CARB	0.1W	5%	120	Ω
R3017	ERJ6GEYJ390	S.M.CARB	0.1W	5%	39	Ω
R3018	ERJ6GEYJ101	S.M.CARB	0.1W	5%	100	Ω
R3019	ERJ6GEYJ101	S.M.CARB	0.1W	5%	100	Ω
R3020	ERJ6GEYJ101	S.M.CARB	0.1W	5%	100	Ω
R3021	ERJ6GEYJ681	S.M.CARB	0.1W	5%	680	Ω
R3022	ERJ6GEYJ680	S.M.CARB	0.1W	5%	68	Ω
R3023	ERQ14AJ390	FUSIBLE	0.25W	5%	39	Ω
R3024	ERJ6GEYJ683	S.M.CARB	0.1W	5%	68K	Ω
R3025	ERJ6GEYJ153	S.M.CARB	0.1W	5%	15K	Ω
R3026	ERJ6GEYJ221	S.M.CARB	0.1W	5%	220	Ω
R3027	ERJ6GEYJ100	S.M.CARB	0.1W	5%	10	Ω
R3028	ERJ6GEYJ681	S.M.CARB	0.1W	5%	680	Ω
R3029	ERJ6GEYJ100	S.M.CARB	0.1W	5%	10	Ω
R3030	ERJ6GEYJ153	S.M.CARB	0.1W	5%	15K	Ω
R3031	ERJ6GEYJ472	S.M.CARB	0.1W	5%	4K7	Ω
R3033	ERJ6GEYJ103	S.M.CARB	0.1W	5%	10K	Ω
R3034	ERJ6GEYJ103	S.M.CARB	0.1W	5%	10K	Ω
R3035	ERJ6GEYJ103	S.M.CARB	0.1W	5%	10K	Ω
R3036	ERJ6GEYJ101	S.M.CARB	0.1W	5%	100	Ω
R3037	ERJ6GEYJ103	S.M.CARB	0.1W	5%	10K	Ω
R3038	ERJ6GEYJ332	S.M.CARB	0.1W	5%	3K3	Ω
R3039	ERJ6GEYJ332	S.M.CARB	0.1W	5%	3K3	Ω
R3040	ERJ6GEYJ101	S.M.CARB	0.1W	5%	100	Ω
R3041	ERJ6GEYJ101	S.M.CARB	0.1W	5%	100	Ω
R3042	ERJ6GEYJ101	S.M.CARB	0.1W	5%	100	Ω
R3043	ERJ6GEYJ471	S.M.CARB	0.1W	5%	470	Ω
R3044	ERJ6GEYJ100	S.M.CARB	0.1W	5%	10	Ω
R3045	ERJ6GEY0R00	S.M.CARB	0.1W	5%	0	Ω
R3046	ERJ6GEYJ102	S.M.CARB	0.1W	5%	1K	Ω
R3047	ERJ6GEY0R00	S.M.CARB	0.1W	5%	0	Ω
R3048	ERJ6GEYJ102	S.M.CARB	0.1W	5%	1K	Ω
R3049	ERJ6GEY0R00	S.M.CARB	0.1W	5%	0	Ω
R3050	ERJ6GEYJ102	S.M.CARB	0.1W	5%	1K	Ω
R3051	ERJ6GEY0R00	S.M.CARB	0.1W	5%	0	Ω
R3052	ERJ6GEYJ102	S.M.CARB	0.1W	5%	1K	Ω
R3053	ERJ6GEYJ220	S.M.CARB	0.1W	5%	22	Ω
R3055	ERJ6GEYJ151	S.M.CARB	0.1W	5%	150	Ω
R3056	ERJ6GEYJ151	S.M.CARB	0.1W	5%	150	Ω
R3057	ERJ6GEYJ151	S.M.CARB	0.1W	5%	150	Ω
R3058	ERJ6GEYJ104	S.M.CARB	0.1W	5%	100K	Ω
R3059	ERJ6GEYJ102	S.M.CARB	0.1W	5%	1K	Ω
R3060	ERJ6GEYJ471	S.M.CARB	0.1W	5%	470	Ω
R3061	ERJ6GEYJ562	S.M.CARB	0.1W	5%	5K6	Ω
R3062	ERJ6GEYJ562	S.M.CARB	0.1W	5%	5K6	Ω
R3063	ERJ6GEYJ222	S.M.CARB	0.1W	5%	2K2	Ω
R3064	ERJ6GEYJ272	S.M.CARB	0.1W	5%	2K7	Ω
R3065	ERJ6GEYJ333	S.M.CARB	0.1W	5%	33K	Ω
R3066	ERJ6GEYJ471	S.M.CARB	0.1W	5%	470	Ω
R3067	ERJ6GEYJ102	S.M.CARB	0.1W	5%	1K	Ω
R3068	ERJ6GEYJ563	S.M.CARB	0.1W	5%	56K	Ω
R3069	ERJ6GEYJ183	S.M.CARB	0.1W	5%	18K	Ω
R3070	ERJ6GEYJ102	S.M.CARB	0.1W	5%	1K	Ω
R3071	ERJ6GEYJ621	S.M. CAR	0.1W	5%	620	Ω

Cct Ref	Parts Number	Description				
R3072	ERJ6GEYJ103	S.M.CARB	0.1W	5%	10K	Ω
R3073	ERJ6GEYJ393	S.M.CARB	0.1W	5%	39K	Ω
R3074	ERJ6GEYJ473	S.M.CARB	0.1W	5%	47K	Ω
R3075	ERJ6GEYJ472	S.M.CARB	0.1W	5%	4K7	Ω
R3076	ERJ6GEYJ331	S.M.CARB	0.1W	5%	330	Ω
R3077	ERJ6GEYJ101	S.M.CARB	0.1W	5%	100	Ω
R3078	ERJ6GEY0R00	S.M.CARB	0.1W	5%	0	Ω
R3079	ERJ6GEYJ101	S.M.CARB	0.1W	5%	100	Ω
R3080	ERJ6GEYJ101	S.M.CARB	0.1W	5%	100	Ω
R3081	ERJ6GEYJ101	S.M.CARB	0.1W	5%	100	Ω
R3082	ERJ6GEYJ101	S.M.CARB	0.1W	5%	100	Ω
R3087	ERJ6GEYJ750	S.M.CARB	0.1W	5%	75	Ω
R3113	ERJ6GEYJ101	S.M.CARB	0.1W	5%	100	Ω
R3114	ERJ6GEYJ101	S.M.CARB	0.1W	5%	100	Ω
R3125	ERJ6GEYJ681	S.M.CARB	0.1W	5%	680	Ω
R3126	ERJ6GEYJ681	S.M.CARB	0.1W	5%	680	Ω
R3281	ERD25TJ750	CARBON	0.25W	5%	75	Ω
R3282	ERD25TJ750	CARBON	0.25W	5%	75	Ω
R3284	ERD25TJ102	CARBON	0.25W	5%	1K	Ω
R3285	ERD25TJ102	CARBON	0.25W	5%	1K	Ω
R3351	ERJ6GEYJ220	S.M.CARB	0.1W	5%	22	Ω
R3352	ERJ6GEYJ472	S.M.CARB	0.1W	5%	4K7	Ω
R3353	ERJ6GEYJ474	S.M.CARB	0.1W	5%	470K	Ω
R3354	ERJ6GEYJ102	S.M.CARB	0.1W	5%	1K	Ω
R3355	ERJ6GEYJ391	S.M.CARB	0.1W	5%	390	Ω
R3356	ERJ6GEYJ682	S.M.CARB	0.1W	5%	6K8	Ω
R3357	ERJ6GEYJ682	S.M.CARB	0.1W	5%	6K8	Ω
R3358	ERJ6GEYJ682	S.M.CARB	0.1W	5%	6K8	Ω
R3360	ERDS1TJ471	CARBON	0.5W	5%	470	Ω
R3361	ERO50PKF1133	METAL	0.5W	5%	110K	Ω
R3401	ERJ6GEYJ101	S.M.CARB	0.1W	5%	100	Ω
R3402	ERJ6GEYJ101	S.M.CARB	0.1W	5%	100	Ω
R3403	ERJ6GEYJ333	S.M.CARB	0.1W	5%	33K	Ω
R3404	ERJ6GEYJ333	S.M.CARB	0.1W	5%	33K	Ω
R3405	ERJ6GEYJ102	S.M.CARB	0.1W	5%	1K	Ω
R3406	ERJ6GEYJ102	S.M.CARB	0.1W	5%	1K	Ω
R3407	ERJ6GEYJ153	S.M.CARB	0.1W	5%	15K	Ω
R3408	ERJ6GEYJ102	S.M.CARB	0.1W	5%	1K	Ω
R3409	ERJ6GEYJ102	S.M.CARB	0.1W	5%	1K	Ω
R3410	ERJ6GEYJ104	S.M.CARB	0.1W	5%	100K	Ω
R3412	ERJ6GEYJ102	S.M.CARB	0.1W	5%	1K	Ω
R3413	ERJ6GEYJ102	S.M.CARB	0.1W	5%	1K	Ω
R3414	ERJ6GEYJ750	S.M.CARB	0.1W	5%	75	Ω
R3415	ERJ6GEYJ104	S.M.CARB	0.1W	5%	100K	Ω
R3416	ERJ6GEYJ333	S.M.CARB	0.1W	5%	33K	Ω
R3417	ERJ6GEYJ104	S.M.CARB	0.1W	5%	100K	Ω
R3418	ERJ6GEYJ104	S.M.CARB	0.1W	5%	100K	Ω
R3419	ERJ6GEYJ333	S.M.CARB	0.1W	5%	33K	Ω
R3420	ERJ6GEYJ750	S.M.CARB	0.1W	5%	75	Ω
R3421	ERJ6GEYJ750	S.M.CARB	0.1W	5%	75	Ω
R3422	ERJ6GEYJ153	S.M.CARB	0.1W	5%	15K	Ω
R3423	ERJ6GEYJ470	S.M.CARB	0.1W	5%	47	Ω
R3424	ERJ6GEYJ101	S.M.CARB	0.1W	5%	100	Ω
R3425	ERJ6GEYJ221	S.M.CARB	0.1W	5%	220	Ω
R3426	ERJ6GEYJ680	S.M.CARB	0.1W	5%	68	Ω
R3427	ERJ6GEYJ102	S.M.CARB	0.1W	5%	1K	Ω
R3428	ERJ6GEYJ680	S.M.CARB	0.1W	5%	68	Ω
R3429	ERJ6GEYJ100	S.M.CARB	0.1W	5%	10	Ω
R3430	ERJ6GEYJ103	S.M.CARB	0.1W	5%	10K	Ω
R3431	ERJ6GEYJ101	S.M.CARB	0.1W	5%	100	Ω
R3432	ERJ6GEYJ221	S.M.CARB	0.1W	5%	220	Ω
R3433	ERJ6GEYJ332	S.M.CARB	0.1W	5%	3K3	Ω
R3434	ERJ6GEYJ333	S.M.CARB	0.1W	5%	33K	Ω
R3435	ERJ6GEYJ680	S.M.CARB	0.1W	5%	68	Ω
R3436	ERJ6GEYJ102	S.M.CARB	0.1W	5%	1K	Ω
R3437	ERJ6GEYJ102	S.M.CARB	0.1W	5%	1K	Ω

Cct Ref	Parts Number	Description				
R3438	ERJ6GEYJ101	S.M.CARB	0.1W	5%	100	Ω
R3439	ERJ6GEYJ333	S.M.CARB	0.1W	5%	33K	Ω
R3440	ERJ6GEYJ102	S.M.CARB	0.1W	5%	1K	Ω
R3441	ERJ6GEYJ153	S.M.CARB	0.1W	5%	15K	Ω
R3443	ERJ6GEYJ750	S.M.CARB	0.1W	5%	75	Ω
R3444	ERJ6GEYJ470	S.M.CARB	0.1W	5%	47	Ω
R3445	ERJ6GEYJ750	S.M.CARB	0.1W	5%	75	Ω
R3446	ERJ6GEYJ102	S.M.CARB	0.1W	5%	1K	Ω
R3447	ERJ6GEYJ102	S.M.CARB	0.1W	5%	1K	Ω
R3452	ERJ6GEYJ101	S.M.CARB	0.1W	5%	100	Ω
R3453	ERJ6GEYJ101	S.M.CARB	0.1W	5%	100	Ω
R3454	ERJ6GEYJ101	S.M.CARB	0.1W	5%	100	Ω
R3455	ERJ6GEYJ101	S.M.CARB	0.1W	5%	100	Ω
R3801	ERJ6GEYJ101	S.M.CARB	0.1W	5%	100	Ω
R3802	ERJ6GEYJ221	S.M.CARB	0.1W	5%	220	Ω
R3803	ERG3FJ100	METAL	3W	5%	10	Ω
R3990	ERJ6GEYJ472	S.M.CARB	0.1W	5%	4K7	Ω
R3991	ERJ6GEYJ103	S.M.CARB	0.1W	5%	10K	Ω
R3992	ERJ6GEYJ103	S.M.CARB	0.1W	5%	10K	Ω
R3993	ERJ6GEYJ103	S.M.CARB	0.1W	5%	10K	Ω
R3994	ERJ6GEYJ103	S.M.CARB	0.1W	5%	10K	Ω
CAPACITORS						
C002	ECA1HMR33GB	ELECT	50V		0.33	μF
C003	ECUV1H104ZFX	S.M. CAP	50V		100n	F
C004	ECUV1H104ZFX	S.M. CAP	50V		100n	F
C005	ECA1CM221GB	ELECT	16V		220	μF
C006	ECUV1H104ZFX	S.M. CAP	50V		100n	F
C007	ECUV1H104ZFX	S.M. CAP	50V		100n	F
C008	ECUV1H561JCX	S.M. CAP	50V		560p	F
C009	ECA1CM221GB	ELECT	16V		220	μF
C010	ECA1HM4R7GB	ELECT	50V		4.7	μF
C011	ECUV1H100DCX	S.M. CAP	50V		10p	F
C012	ECUV1H100DCX	S.M. CAP	50V		10p	F
C013	ECA1CM470GB	ELECT	16V		47	μF
C014	ECUV1H104ZFX	S.M. CAP	50V		100n	F
C015	ECUV1H104ZFX	S.M. CAP	50V		100n	F
C017	ECUV1H100DCX	S.M. CAP	50V		10p	F
C018	ECJ2VF1H104Z	ELECT	350V		100n	F
C019	ECJ2VF1H104Z	ELECT	350V		100n	F
C103	ECUV1H104ZFX	S.M. CAP	50V		100n	F
C104	ECJ2VF1H103Z	ELECT	350V		10n	F
C107	ECUV1H104ZFX	S.M. CAP	50V		100n	F
C108	ECUV1H104ZFX	S.M. CAP	50V		100n	F
C109	ECUV1C184KBX	S.M. CAP	16V		180n	F
C110	ECUV1H104ZFX	S.M. CAP	50V		100n	F
C111	ECUV1H104ZFX	S.M. CAP	50V		100n	F
C251	ECA1HM101GB	ELECT	50V		100	μF
C253	ECA1HM100GB	ELECT	50V		10	μF
C255	ECA1EHG101B	ELECT	50V		100n	F
C257	ECA1HM100GB	ELECT	50V		10	μF
C258	ECA1HM101GB	ELECT	50V		100	μF
C260	ECA1VM102GB	ELECT	35V		1n	F
C261	ECA1VM102GB	ELECT	35V		1n	F
C263	ECA1HM4R7GB	ELECT	50V		4.7	μF
C264	ECA1HM222E	ELECT	50V		2.2n	F
C266	ECA1HM4R7GB	ELECT	50V		4.7	μF
C267	ECQM1H224J	FILM	50V		220n	F
C268	ECQM1H224J	FILM	50V		220n	F
C269	ECA1HM470GB	ELECT	50V		47	μF
C270	ECQM1H224J	FILM	50V		220n	F
C271	ECQM1H224J	FILM	50V		220n	F
C277	ECUV1H102JCX	S.M. CAP	50V		1n	F
C278	ECUV1H102JCX	S.M. CAP	50V		1n	F
C281	ECA1HM010GB	ELECT	50V		1	μF
C282	ECA1HM010GB	ELECT	50V		1	μF
C283	ECJ2VF1H223Z	ELECT	350V		22n	F

Cct Ref	Parts Number	Description			
C284	ECUV1H102KBX	S.M. CAP	50V	1nF	
C285	ECA1HM470GB	ELECT	50V	47µF	
C286	ECUV1H562KBX	S.M. CAP	50V	5.6nF	
C287	ECA1HM470GB	ELECT	50V	47µF	
C288	ECA1HM010GB	ELECT	50V	1µF	
C289	ECUV1H103KBX	S.M. CAP	50V	10nF	
C290	ECQM1H474J	FILM	50V	470nF	
C291	ECA1VM102GB	ELECT	35V	1nF	
C292	ECQM1H474J	FILM	50V	470nF	
C293	ECUV1H102JCX	S.M. CAP	50V	1nF	
C352	ECUV1H224ZFX	S.M. CAP	50V	220nF	
C353	ECUV1H104KBX	S.M. CAP	50V	100nF	
C354	ECQM2104KZ	FILM	250V	100nF	
C355	ECKC2H102J	CERAMIC	500V	1nF	⚠
C362	ECUV1H224ZFX	S.M. CAP	50V	220nF	
C363	ECUV1H104KBX	S.M. CAP	50V	100nF	
C364	ECQM2104KZ	FILM	250V	100nF	
C365	ECKC2H102J	CERAMIC	500V	1nF	⚠
C372	ECUV1H224ZFX	S.M. CAP	50V	220nF	
C373	ECUV1H104KBX	S.M. CAP	50V	100nF	
C374	ECQM2104KZ	FILM	250V	100nF	
C375	ECKC2H102J	CERAMIC	500V	1nF	⚠
C381	ECA1HM101GB	ELECT	50V	100µF	
C382	ECA1CM471GB	ELECT	16V	470µF	
C383	ECUV1H103KBX	S.M. CAP	50V	10nF	
C384	ECQM2104KZ	FILM	250V	100nF	
C385	ECA2EM220B	ELECT	250V	22µF	
C387	ECUV1H681JCX	S.M. CAP	50V	680pF	
C395	ECQM1H104J	FILM	50V	100nF	
C396	ECJ2VF1H104Z	ELECT	350V	100nF	
C400	ECA1VM102GB	ELECT	35V	1nF	
C402	ECA1HM010GB	ELECT	50V	1µF	
C404	ECEA1HU471	ELECT	50V	470µF	
C407	ECQB1224KFW	FILM	100V	220nF	
C411	ECUV1H102KBX	S.M. CAP	50V	1nF	
C501	ECQM1H224J	FILM	50V	220nF	
C502	ECQM2104KZ	FILM	250V	100nF	
C503	ECKC2H102J	CERAMIC	500V	1nF	⚠
C504	ECQB1H223K	FILM	50V	22nF	
C505	ECA1EM332E	ELECT	25V	3300µF	
C506	ECKC2H102J	CERAMIC	500V	1nF	⚠
C507	ECA1EM332E	ELECT	25V	3300µF	
C552	ECWH20102JVY	FILM	200V	1µF	
C553	ECQP1223JZW	FILM	100V	22nF	
C554	ECQB1H152K	FILM	50V	1.5nF	
C555	ECWH20622JVB	FILM	200V	6.2nF	
C556	ECEA2CNR47SB	ELECT	160V	0.47µF	
C557	ECKC2H331J	CERAMIC	500V	330pF	⚠
C558	ECA2EM330B	ELECT	250V	33µF	
C563	ECWF2564JBB	FILM	200V	560nF	⚠
C565	ECQP1223JZW	FILM	100V	22nF	
C581	ECQF4123JZH	FILM	400V	12nF	⚠
C584	ECKC3D391J	CERAMIC	2KV	390pF	⚠
C602	ECUV1H104ZFX	S.M. CAP	50V	100nF	
C603	ECUV1H104ZFX	S.M. CAP	50V	100nF	
C604	ECUV1H470JCX	S.M. CAP	50V	47pF	
C605	ECA1CM221GB	ELECT	16V	220µF	
C606	ECA1AM332E	ELECT	10V	3300µF	
C607	ECUV1H104ZFX	S.M. CAP	50V	100nF	
C608	ECUV1H104ZFX	S.M. CAP	50V	100nF	
C609	ECA1HM3R3GB	ELECT	50V	3.3µF	
C610	ECUV1H104ZFX	S.M. CAP	50V	100nF	
C611	ECUV1H104ZFX	S.M. CAP	50V	100nF	
C612	ECUV1H104ZFX	S.M. CAP	50V	100nF	
C613	ECUV1H104ZFX	S.M. CAP	50V	100nF	
C614	ECUV1H104ZFX	S.M. CAP	50V	100nF	

Cct Ref	Parts Number	Description			
C615	ECJ2VB1C104K	ELECT	350V	100nF	
C616	ECQM1H104J	FILM	50V	100nF	
C617	ECUV1H104ZFX	S.M. CAP	50V	100nF	
C618	ECUV1H104ZFX	S.M. CAP	50V	100nF	
C620	ECUV1H100DCX	S.M. CAP	50V	10pF	
C622	ECUV1H470JCX	S.M. CAP	50V	47pF	
C623	ECUV1H470JCX	S.M. CAP	50V	47pF	
C624	ECUV1H820JCX	S.M. CAP	50V	82pF	
C625	ECUV1H470JCX	S.M. CAP	50V	47pF	
C626	ECUV1H470JCX	S.M. CAP	50V	47pF	
C627	ECUV1H470JCX	S.M. CAP	50V	47pF	
C628	ECUV1H470JCX	S.M. CAP	50V	47pF	
C632	ECUV1H104ZFX	S.M. CAP	50V	100nF	
C633	ECUV1H104ZFX	S.M. CAP	50V	100nF	
C634	ECUV1H222KBX	S.M. CAP	50V	2.2nF	
C635	ECA1EM101GB	ELECT	25V	100µF	
C636	ECUV1H103ZFX	S.M. CAP	50V	10nF	
C637	ECUV1H470JCX	S.M. CAP	50V	47pF	
C638	ECUV1H270JCX	S.M. CAP	50V	27pF	
C639	ECUV1H104ZFX	S.M. CAP	50V	100nF	
C641	ECUV1H101JCX	S.M. CAP	50V	100pF	
C643	ECUV1H102KBX	S.M. CAP	50V	1nF	
C646	ECUV1H103KBX	S.M. CAP	50V	10nF	
C651	ECUV1C224KBX	S.M. CAP	16V	220nF	
C701	ECQV1H105JZ	FILM	50V	1µF	
C702	ECKC2H102J	CERAMIC	500V	1nF	⚠
C806	ECQE6104K	FILM	600V	100nF	⚠
C807	ECQB1H473K	FILM	50V	47nF	
C808	ECQM1H334J	FILM	50V	330nF	
C812	ECQB1H562K	FILM	50V	5.6nF	
C813	ECKC2H472J	CERAMIC	500V	4.7nF	⚠
C814	ECKC2H472J	CERAMIC	500V	4.7nF	⚠
C815	ECA1CM331B	ELECT	16V	330µF	
C816	ECQB1H122J	FILM	50V	1.2nF	
C817	ECKC2H472J	CERAMIC	500V	4.7nF	⚠
C818	ECKC2H472J	CERAMIC	500V	4.7nF	⚠
C819	ECOS2WB221DB	ELECT	16V	220µF	
C820	ECOS2WB221DB	ELECT	16V	220µF	
C821	ECQB1H222J	FILM	50V	2.2nF	
C822	ECKC3D471JB	CERAMIC	2KV	470pF	⚠
C823	EEUFA1V221B	CERAMIC	35V	220µF	
C824	ECQB1H221KF3	FILM	50V	220µF	
C826	ECQB1H473K	FILM	50V	47nF	
C827	ECKCNS332J	CERAMIC	1.2KV	3.3nF	⚠
C830	ECQE6105JFW	FILM	600V	1µF	⚠
C831	ECKC3D471JB	CERAMIC	2KV	470pF	⚠
C833	ECQB1H682K	FILM	50V	6.8nF	
C835	ECQB1H332K	FILM	50V	3.3nF	
C842	ECQE2A474MWB	FILM	100V	470nF	
C847	ECEA1EN101UB	ELECT	25V	100µF	
C848	ECKC2H331J	CERAMIC	500V	330pF	⚠
C849	ECKC2H391J	CERAMIC	500V	390pF	⚠
C853	ECEA1CU332	ELECT	16V	3300µF	
C854	ECA1EM221GB	ELECT	25V	220pF	
C855	ECEA1HU102	ELECT	50V	1000µF	
C857	ECA1EM471GB	ELECT	25V	470µF	
C858	ECOS2EA271BB	ELECT	250V	270µF	
C859	ECKC2H471J	CERAMIC	500V	470pF	⚠
C861	ECOS2EA221AB	ELECT	250V	220µF	
C863	ECA1EM332E	ELECT	25V	3300µF	
C864	ECA0JM102GB	ELECT	6.3V	1000µF	
C866	ECA1HM101GB	ELECT	50V	100µF	
C867	ECA1CM222E	ELECT	16V	2.2nF	
C868	ECA1CM100GB	ELECT	16V	10µF	
C869	ECA1HM101GB	ELECT	50V	100µF	
C871	ECA0JM102GB	ELECT	6.3V	1000µF	

Cct Ref	Parts Number	Description		
C872	ECA1CM222E	ELECT	16V	2.2nF
C901	ECUV1H030CCX	S.M. CAP	50V	30pF
C902	ECA1VM101GB	ELECT	35V	100µF
C904	ECJ2VF1H103Z	ELECT	350V	10nF
C907	ECUV1H121JCX	S.M. CAP	50V	120pF
C908	ECUV1H151JCX	S.M. CAP	50V	150pF
C909	ECKC2H472J	CERAMIC	500V	4.7nF
C910	ECKC2H472J	CERAMIC	500V	4.7nF
C911	ECUV1H151JCX	S.M. CAP	50V	150pF
C912	ECA2EM220B	ELECT	250V	22µF
C913	ECA1HM101GB	ELECT	50V	100µF
C914	ECA1HM101GB	ELECT	50V	100µF
C916	ECA2EM220B	ELECT	250V	22µF
C917	ECA1HM100GB	ELECT	50V	10µF
C918	ECJ2VF1H103Z	ELECT	350V	10nF
C1011	ECKC1H101J	CERAMIC	50V	100pF
C1012	ECA1VM470B	ELECT	35V	47µF
C1013	ECKC1H103JB	CERAMIC	50V	10nF
C1014	ECA1HM101GB	ELECT	50V	100µF
C1101	ECUV1H104ZFX	S.M. CAP	50V	100nF
C1102	ECUV1H101JCX	S.M. CAP	50V	100pF
C1103	ECUV1H220JCX	S.M. CAP	50V	22pF
C1104	ECUV1H220JCX	S.M. CAP	50V	22pF
C1107	ECUV1H104ZFX	S.M. CAP	50V	100nF
C1108	ECUV1C104KBX	S.M. CAP	16V	100nF
C1109	ECUV1C104KBX	S.M. CAP	16V	100nF
C1113	ECUV1C104KBX	S.M. CAP	16V	100nF
C1114	ECA1HM101GB	ELECT	50V	100µF
C1116	ECUV1H560JCX	S.M. CAP	50V	56pF
C1117	ECUV1H221JCX	S.M. CAP	50V	220pF
C1118	ECJ3VB1C474K	ELECT	3.5KV	470nF
C1120	ECUV1H104ZFX	S.M. CAP	50V	100nF
C1121	ECUV1H472KBX	S.M. CAP	50V	4.7nF
C1122	ECA1HM010GB	ELECT	50V	1µF
C1123	ECUV1H104ZFX	S.M. CAP	50V	100nF
C1124	ECUV1H101JCX	S.M. CAP	50V	100pF
C1125	ECUV1H104ZFX	S.M. CAP	50V	100nF
C1126	ECUV1H104ZFX	S.M. CAP	50V	100nF
C1127	ECA1HM101GB	ELECT	50V	100µF
C1128	ECUV1H104ZFX	S.M. CAP	50V	100nF
C1129	ECA1HM101GB	ELECT	50V	100µF
C1130	ECUV1H103KBX	S.M. CAP	50V	10nF
C1131	ECUV1H221JCX	S.M. CAP	50V	220pF
C1138	ECUV1H224ZFX	S.M. CAP	50V	220nF
C1145	ECJ2VB1H333K	ELECT	350V	33nF
C1147	ECA1CM331B	ELECT	16V	330µF
C1148	ECUV1C224KBX	S.M. CAP	16V	220nF
C1501	ECUV1H330JCX	S.M. CAP	50V	33pF
C1502	ECUV1H471JCX	S.M. CAP	50V	470pF
C1503	ECUV1H390JCX	S.M. CAP	50V	39pF
C1504	ECUV1H680JCX	S.M. CAP	50V	68pF
C1505	ECUV1H820JCX	S.M. CAP	50V	82pF
C1506	ECUV1H331JCX	S.M. CAP	50V	330pF
C1507	ECUV1H102KBX	S.M. CAP	50V	1nF
C1508	ECEA1HN010UB	ELECT	50V	1µF
C1509	ECUV1H104ZFX	S.M. CAP	50V	100nF
C1510	ECA1HM101GB	ELECT	50V	100µF
C1511	ECUV1H104ZFX	S.M. CAP	50V	100nF
C1512	ECUV1H030CCX	S.M. CAP	50V	30pF
C1513	ECA1HM100GB	ELECT	50V	10µF
C1514	ECUV1H104ZFX	S.M. CAP	50V	100nF
C1515	ECUV1H104ZFX	S.M. CAP	50V	100nF
C1516	ECUV1H030CCX	S.M. CAP	50V	30pF
C1517	ECUV1H473ZFX	S.M. CAP	50V	47nF
C1518	ECUV1H104ZFX	S.M. CAP	50V	100nF
C1519	ECA1HM101GB	ELECT	50V	100µF

Cct Ref	Parts Number	Description		
C1521	ECA1HM101GB	ELECT	50V	100µF
C1522	ECUV1H104ZFX	S.M. CAP	50V	100nF
C1523	ECUV1H104ZFX	S.M. CAP	50V	100nF
C1524	ECA1VM470B	ELECT	35V	47µF
C1525	ECUV1H104ZFX	S.M. CAP	50V	100nF
C1527	ECUV1H104ZFX	S.M. CAP	50V	100nF
C1528	ECUV1H104ZFX	S.M. CAP	50V	100nF
C1529	ECUV1H104ZFX	S.M. CAP	50V	100nF
C1530	ECUV1H104ZFX	S.M. CAP	50V	100nF
C1532	ECUV1H104ZFX	S.M. CAP	50V	100nF
C1533	ECUV1H104ZFX	S.M. CAP	50V	100nF
C1534	ECUV1H104ZFX	S.M. CAP	50V	100nF
C1535	ECUV1H104ZFX	S.M. CAP	50V	100nF
C1536	ECUV1H104ZFX	S.M. CAP	50V	100nF
C1537	ECUV1H104ZFX	S.M. CAP	50V	100nF
C1538	EEUNA1E220B	CERAMIC	25V	22µF
C1539	ECUV1H104ZFX	S.M. CAP	50V	100nF
C1540	ECUV1H104ZFX	S.M. CAP	50V	100nF
C1541	ECUV1H104ZFX	S.M. CAP	50V	100nF
C1542	ECA1CM471GB	ELECT	16V	470µF
C1543	ECUV1H104ZFX	S.M. CAP	50V	100nF
C1544	EEUNA1E220B	CERAMIC	25V	22µF
C1545	ECUV1H104ZFX	S.M. CAP	50V	100nF
C1546	ECA1HM101GB	ELECT	50V	100µF
C1547	ECUV1H104ZFX	S.M. CAP	50V	100nF
C1548	ECUV1H104ZFX	S.M. CAP	50V	100nF
C1549	ECUV1H104ZFX	S.M. CAP	50V	100nF
C1550	ECUV1H104ZFX	S.M. CAP	50V	100nF
C1551	EEUNA1E220B	CERAMIC	25V	22µF
C1552	ECA1HM101GB	ELECT	50V	100µF
C1553	ECUV1H104ZFX	S.M. CAP	50V	100nF
C1554	ECUV1H104ZFX	S.M. CAP	50V	100nF
C1555	ECUV1H104ZFX	S.M. CAP	50V	100nF
C1556	ECA1HM101GB	ELECT	50V	100µF
C1557	ECUV1H104ZFX	S.M. CAP	50V	100nF
C1558	ECUV1H104ZFX	S.M. CAP	50V	100nF
C1559	ECUV1H104ZFX	S.M. CAP	50V	100nF
C1560	ECUV1H104ZFX	S.M. CAP	50V	100nF
C1561	ECUV1H104ZFX	S.M. CAP	50V	100nF
C1562	ECUV1H104ZFX	S.M. CAP	50V	100nF
C1563	ECA1HM101GB	ELECT	50V	100µF
C1564	ECUV1H104ZFX	S.M. CAP	50V	100nF
C1565	ECUV1H270JCX	S.M. CAP	50V	27pF
C1567	ECA1HM101GB	ELECT	50V	100µF
C1568	ECUV1H104ZFX	S.M. CAP	50V	100nF
C1569	ECUV1H104ZFX	S.M. CAP	50V	100nF
C1570	ECUV1H104ZFX	S.M. CAP	50V	100nF
C1571	ECA1CM471GB	ELECT	16V	470µF
C1572	ECUV1H104ZFX	S.M. CAP	50V	100nF
C1573	ECUV1H104ZFX	S.M. CAP	50V	100nF
C1574	ECUV1H104ZFX	S.M. CAP	50V	100nF
C1575	ECUV1H104ZFX	S.M. CAP	50V	100nF
C1576	ECUV1H104ZFX	S.M. CAP	50V	100nF
C1577	ECUV1H104ZFX	S.M. CAP	50V	100nF
C1578	ECUV1H104ZFX	S.M. CAP	50V	100nF
C1579	ECUV1H104ZFX	S.M. CAP	50V	100nF
C1580	ECUV1H104ZFX	S.M. CAP	50V	100nF
C1581	ECUV1H104ZFX	S.M. CAP	50V	100nF
C1582	ECUV1H104ZFX	S.M. CAP	50V	100nF
C1583	ECUV1H104ZFX	S.M. CAP	50V	100nF
C1584	ECUV1H104ZFX	S.M. CAP	50V	100nF
C1585	ECUV1H104ZFX	S.M. CAP	50V	100nF
C1586	ECUV1H104ZFX	S.M. CAP	50V	100nF
C1587	ECUV1H104ZFX	S.M. CAP	50V	100nF
C1588	ECUV1H104ZFX	S.M. CAP	50V	100nF
C1589	ECUV1H104ZFX	S.M. CAP	50V	100nF

Cct Ref	Parts Number	Description		
C1590	ECUV1H104ZFX	S.M. CAP	50V	100nF
C1591	ECUV1H104ZFX	S.M. CAP	50V	100nF
C1592	ECA1CM221GB	ELECT	16V	220µF
C1593	ECA1CM221GB	ELECT	16V	220µF
C1594	ECUV1H104ZFX	S.M. CAP	50V	100nF
C1595	ECUV1H104ZFX	S.M. CAP	50V	100nF
C1596	ECUV1H104ZFX	S.M. CAP	50V	100nF
C1597	ECUV1H104ZFX	S.M. CAP	50V	100nF
C1598	ECUV1H104ZFX	S.M. CAP	50V	100nF
C1599	ECUV1H104ZFX	S.M. CAP	50V	100nF
C1600	ECUV1H104ZFX	S.M. CAP	50V	100nF
C1601	ECUV1H104ZFX	S.M. CAP	50V	100nF
C1602	ECUV1H104ZFX	S.M. CAP	50V	100nF
C1603	ECUV1H104ZFX	S.M. CAP	50V	100nF
C1604	ECUV1H104ZFX	S.M. CAP	50V	100nF
C1605	ECUV1H104ZFX	S.M. CAP	50V	100nF
C1606	ECUV1H104ZFX	S.M. CAP	50V	100nF
C1607	ECUV1H104ZFX	S.M. CAP	50V	100nF
C1608	ECUV1H104ZFX	S.M. CAP	50V	100nF
C1609	ECUV1H104ZFX	S.M. CAP	50V	100nF
C1610	ECUV1H104ZFX	S.M. CAP	50V	100nF
C1611	ECA1CM471GB	ELECT	16V	470µF
C1612	ECUV1H104ZFX	S.M. CAP	50V	100nF
C1614	ECUV1H104ZFX	S.M. CAP	50V	100nF
C1615	ECUV1H104ZFX	S.M. CAP	50V	100nF
C1616	ECUV1H104ZFX	S.M. CAP	50V	100nF
C1617	ECUV1H104ZFX	S.M. CAP	50V	100nF
C1618	ECUV1H104ZFX	S.M. CAP	50V	100nF
C1619	ECUV1H104ZFX	S.M. CAP	50V	100nF
C1620	ECUV1H104ZFX	S.M. CAP	50V	100nF
C1621	ECUV1H104ZFX	S.M. CAP	50V	100nF
C1622	ECUV1H104ZFX	S.M. CAP	50V	100nF
C1623	ECUV1H104ZFX	S.M. CAP	50V	100nF
C1624	ECUV1H104ZFX	S.M. CAP	50V	100nF
C1625	ECUV1H104ZFX	S.M. CAP	50V	100nF
C1626	ECUV1H104ZFX	S.M. CAP	50V	100nF
C1627	ECUV1H104ZFX	S.M. CAP	50V	100nF
C1628	ECUV1H104ZFX	S.M. CAP	50V	100nF
C1629	ECUV1H104ZFX	S.M. CAP	50V	100nF
C1630	ECUV1H104ZFX	S.M. CAP	50V	100nF
C1631	ECUV1H104ZFX	S.M. CAP	50V	100nF
C1632	ECUV1H104ZFX	S.M. CAP	50V	100nF
C1633	ECUV1H104ZFX	S.M. CAP	50V	100nF
C1636	ECUV1H104ZFX	S.M. CAP	50V	100nF
C1637	ECUV1H104ZFX	S.M. CAP	50V	100nF
C1638	ECUV1H104ZFX	S.M. CAP	50V	100nF
C1639	ECUV1H104ZFX	S.M. CAP	50V	100nF
C1642	ECUV1H104ZFX	S.M. CAP	50V	100nF
C1643	ECUV1H104ZFX	S.M. CAP	50V	100nF
C1644	ECUV1H104ZFX	S.M. CAP	50V	100nF
C1645	ECUV1H104ZFX	S.M. CAP	50V	100nF
C1647	ECUV1H470JCX	S.M. CAP	50V	47pF
C1648	ECUV1H104ZFX	S.M. CAP	50V	100nF
C1649	ECA1HM101GB	ELECT	50V	100µF
C1650	ECUV1H104ZFX	S.M. CAP	50V	100nF
C1651	ECUV1H104ZFX	S.M. CAP	50V	100nF
C1652	ECA1HM101GB	ELECT	50V	100µF
C1653	ECUV1H104ZFX	S.M. CAP	50V	100nF
C1654	ECUV1H104ZFX	S.M. CAP	50V	100nF
C1655	ECA1VM470B	ELECT	35V	47µF
C1656	ECUV1H104ZFX	S.M. CAP	50V	100nF
C1658	ECUV1H104ZFX	S.M. CAP	50V	100nF
C1659	ECA1VM470B	ELECT	35V	47µF
C1660	ECUV1H104ZFX	S.M. CAP	50V	100nF
C1661	ECA1HM101GB	ELECT	50V	100µF
C1662	ECUV1H104ZFX	S.M. CAP	50V	100nF

Cct Ref	Parts Number	Description		
C1664	ECUV1H104ZFX	S.M. CAP	50V	100nF
C1666	ECUV1H390JCX	S.M. CAP	50V	39pF
C1667	ECUV1H820JCX	S.M. CAP	50V	82pF
C1668	ECUV1H680JCX	S.M. CAP	50V	68pF
C1669	ECUV1H271JCX	S.M. CAP	50V	270pF
C1670	ECUV1H391JCX	S.M. CAP	50V	390pF
C1671	ECUV1H390JCX	S.M. CAP	50V	39pF
C1672	ECUV1H820JCX	S.M. CAP	50V	82pF
C1673	ECUV1H680JCX	S.M. CAP	50V	68pF
C1674	ECUV1H271JCX	S.M. CAP	50V	270pF
C1675	ECUV1H391JCX	S.M. CAP	50V	390pF
C1676	ECUV1H390JCX	S.M. CAP	50V	39pF
C1677	ECUV1H820JCX	S.M. CAP	50V	82pF
C1678	ECUV1H680JCX	S.M. CAP	50V	68pF
C1679	ECUV1H271JCX	S.M. CAP	50V	270pF
C1680	ECUV1H391JCX	S.M. CAP	50V	390pF
C1681	ECUV1H820JCX	S.M. CAP	50V	82pF
C1682	ECUV1H104ZFX	S.M. CAP	50V	100nF
C1683	ECUV1H101JCX	S.M. CAP	50V	100pF
C1685	ECUV1H104ZFX	S.M. CAP	50V	100nF
C1686	ECUV1H101JCX	S.M. CAP	50V	100pF
C1688	ECUV1H104ZFX	S.M. CAP	50V	100nF
C1689	ECUV1H104ZFX	S.M. CAP	50V	100nF
C1690	ECJ2VF1C105Z	ELECT	350V	1µF
C1691	ECJ2VF1C105Z	ELECT	350V	1µF
C1692	EEUNA1E220B	CERAMIC	25V	22µF
C1693	ECA1HM101GB	ELECT	50V	100µF
C1696	EEUNA1E220B	CERAMIC	25V	22µF
C1697	EEUNA1E220B	CERAMIC	25V	22µF
C1698	EEUNA1E220B	CERAMIC	25V	22µF
C1801	ECA1HM101GB	ELECT	50V	100µF
C1802	ECA1HM101GB	ELECT	50V	100µF
C1803	ECUV1H104ZFX	S.M. CAP	50V	100nF
C1804	ECUV1H104ZFX	S.M. CAP	50V	100nF
C1805	ECUV1H150JCX	S.M. CAP	50V	15pF
C1806	ECUV1H150JCX	S.M. CAP	50V	15pF
C1807	ECUV1H104ZFX	S.M. CAP	50V	100nF
C1808	ECUV1H104ZFX	S.M. CAP	50V	100nF
C1809	ECUV1H104ZFX	S.M. CAP	50V	100nF
C1810	ECA1HM101GB	ELECT	50V	100µF
C1811	ECUV1H220JCX	S.M. CAP	50V	22pF
C1812	ECJ2VB1C104K	ELECT	350V	100nF
C1813	ECUV1H104ZFX	S.M. CAP	50V	100nF
C1814	ECUV1H040CCX	S.M. CAP	50V	4µF
C1815	ECUV1H220JCX	S.M. CAP	50V	22pF
C1816	ECUV1H104ZFX	S.M. CAP	50V	100nF
C1817	ECUV1H331JCX	S.M. CAP	50V	330pF
C1818	ECJ2VB1C104K	ELECT	350V	100nF
C1819	ECA1HM101GB	ELECT	50V	100µF
C1820	ECUV1H680JCX	S.M. CAP	50V	68pF
C1821	ECUV1H104ZFX	S.M. CAP	50V	100nF
C1823	ECUV1H331JCX	S.M. CAP	50V	330pF
C1824	ECUV1H104ZFX	S.M. CAP	50V	100nF
C1825	ECUV1C104KBX	S.M. CAP	16V	100nF
C1826	ECUV1C104KBX	S.M. CAP	16V	100nF
C1827	ECUV1C104KBX	S.M. CAP	16V	100nF
C1828	ECUV1H150JCX	S.M. CAP	50V	15pF
C1829	ECUV1C104KBX	S.M. CAP	16V	100nF
C1830	ECUV1C104KBX	S.M. CAP	16V	100nF
C1831	ECUV1C104KBX	S.M. CAP	16V	100nF
C1832	ECUV1H104ZFX	S.M. CAP	50V	100nF
C1833	ECUV1H180JCX	S.M. CAP	50V	18pF
C1834	ECUV1H104ZFX	S.M. CAP	50V	100nF
C1835	ECUV1C104KBX	S.M. CAP	16V	100nF
C1836	ECUV1H332KBX	S.M. CAP	50V	3.3nF
C1837	ECUV1C104KBX	S.M. CAP	16V	100nF

Cct Ref	Parts Number	Description		
C1838	ECUV1C104KBX	S.M. CAP	16V	100nF
C1840	ECUV1H332KBX	S.M. CAP	50V	3.3nF
C1842	ECA1HM101GB	ELECT	50V	100µF
C1843	ECUV1H104ZFX	S.M. CAP	50V	100nF
C1847	ECUV1H331JCX	S.M. CAP	50V	330pF
C1848	ECUV1H102KBX	S.M. CAP	50V	1nF
C1849	ECUV1H102KBX	S.M. CAP	50V	1nF
C2103	ECUV1H391KBX	S.M. CAP	50V	390pF
C2104	ECUV1H102KBX	S.M. CAP	50V	1nF
C2105	ECUV1H102KBX	S.M. CAP	50V	1nF
C2106	ECUV1H102KBX	S.M. CAP	50V	1nF
C2107	ECUV1H102KBX	S.M. CAP	50V	1nF
C2108	ECUV1H102KBX	S.M. CAP	50V	1nF
C2109	ECUV1H102KBX	S.M. CAP	50V	1nF
C2110	ECUV1H102KBX	S.M. CAP	50V	1nF
C2111	ECA1CM100GB	ELECT	16V	10µF
C2112	ECUV1H104ZFX	S.M. CAP	50V	100nF
C2113	ECA1CM100GB	ELECT	16V	10µF
C2114	ECA1HM101GB	ELECT	50V	100µF
C2115	ECUV1H104ZFX	S.M. CAP	50V	100nF
C2116	ECUV1H102KBX	S.M. CAP	50V	1nF
C2117	ECUV1H471KBX	S.M. CAP	50V	470pF
C2118	ECA1HM3R3GB	ELECT	50V	3.3µF
C2119	ECUV1H471KBX	S.M. CAP	50V	470pF
C2120	ECUV1H104ZFX	S.M. CAP	50V	100nF
C2121	ECUV1H221JCX	S.M. CAP	50V	220pF
C2122	ECUV1H221JCX	S.M. CAP	50V	220pF
C2123	ECUV1H221JCX	S.M. CAP	50V	220pF
C2124	ECUV1H104ZFX	S.M. CAP	50V	100nF
C2125	ECA1CM100GB	ELECT	16V	10µF
C2126	ECUV1H221JCX	S.M. CAP	50V	220pF
C2127	ECUV1H104ZFX	S.M. CAP	50V	100nF
C2128	ECUV1H221JCX	S.M. CAP	50V	220pF
C2129	ECA1CM100GB	ELECT	16V	10µF
C2130	ECUV1H221JCX	S.M. CAP	50V	220pF
C2131	ECQM1H334J	FILM	50V	330nF
C2132	ECA1CM100GB	ELECT	16V	10µF
C2133	ECUV1H470JCX	S.M. CAP	50V	47pF
C2134	ECUV1H470JCX	S.M. CAP	50V	47pF
C2135	ECUV1H070DCX	S.M. CAP	50V	7pF
C2137	ECUV1H104ZFX	S.M. CAP	50V	100nF
C2138	ECUV1H010CCX	S.M. CAP	50V	1pF
C2139	ECUV1H010CCX	S.M. CAP	50V	1pF
C2141	ECUV1H560JCX	S.M. CAP	50V	56pF
C2142	ECA1CM100GB	ELECT	16V	10µF
C2144	ECUV1H560JCX	S.M. CAP	50V	56pF
C2146	ECA1CM100GB	ELECT	16V	10µF
C2147	ECUV1H103KBX	S.M. CAP	50V	10nF
C2148	ECUV1H103KBX	S.M. CAP	50V	10nF
C2301	ECA1CM470GB	ELECT	16V	47µF
C2302	ECA1CM470GB	ELECT	16V	47µF
C2307	ECUV1H103KBX	S.M. CAP	50V	10nF
C2308	ECUV1H103KBX	S.M. CAP	50V	10nF
C2353	ECA1CM471GB	ELECT	16V	470µF
C2356	ECA1HM4R7GB	ELECT	50V	4.7µF
C2357	ECUV1H151JCX	S.M. CAP	50V	150pF
C2358	ECUV1H151JCX	S.M. CAP	50V	150pF
C2359	ECA1HM4R7GB	ELECT	50V	4.7µF
C2361	ECA1CM470GB	ELECT	16V	47µF
C2362	ECA1HM101GB	ELECT	50V	100µF
C2363	ECEA1HU221	ELECT	50V	220µF
C2364	ECEA1HU221	ELECT	50V	220µF
C2365	ECA1HM101GB	ELECT	50V	100µF
C2366	ECA0JM222GB	ELECT	6.3V	2.2nF
C2367	ECUV1H104ZFX	S.M. CAP	50V	100nF
C2370	ECA1HM100GB	ELECT	50V	10µF

Cct Ref	Parts Number	Description		
C2371	ECUV1H472KBX	S.M. CAP	50V	4.7nF
C2372	ECUV1H472KBX	S.M. CAP	50V	4.7nF
C2375	ECUV1H104ZFX	S.M. CAP	50V	100nF
C2377	ECKC1H102J	CERAMIC	50V	1nF
C2378	ECKC1H102J	CERAMIC	50V	1nF
C2381	ECKC1H103JB	CERAMIC	50V	10nF
C2382	ECKC1H103JB	CERAMIC	50V	10nF
C2430	ECUV1H561JCX	S.M. CAP	50V	560pF
C2431	ECUV1H561JCX	S.M. CAP	50V	560pF
C2437	ECUV1H561JCX	S.M. CAP	50V	560pF
C2438	ECUV1H561JCX	S.M. CAP	50V	560pF
C2501	ECA1HM101GB	ELECT	50V	100µF
C3001	ECUV1H103ZFX	S.M. CAP	50V	10nF
C3002	ECA1CM470GB	ELECT	16V	47µF
C3003	ECUV1H102ZFX	S.M. CAP	50V	1nF
C3004	ECUV1H104ZFX	S.M. CAP	50V	100nF
C3005	ECUV1H104ZFX	S.M. CAP	50V	100nF
C3006	ECA1HM4R7GB	ELECT	50V	4.7µF
C3007	ECA1HM4R7GB	ELECT	50V	4.7µF
C3008	ECUV1H104ZFX	S.M. CAP	50V	100nF
C3009	ECUV1H473ZFX	S.M. CAP	50V	47nF
C3010	ECUV1H680JCX	S.M. CAP	50V	68pF
C3011	ECA1CM221GB	ELECT	16V	220µF
C3012	ECA1CM470GB	ELECT	16V	47µF
C3013	ECA1CM470GB	ELECT	16V	47µF
C3014	EEUNA1A470B	CERAMIC	10V	47µF
C3015	ECUV1H104ZFX	S.M. CAP	50V	100nF
C3016	ECA1CM470GB	ELECT	16V	47µF
C3017	ECUV1H104ZFX	S.M. CAP	50V	100nF
C3018	ECUV1H104ZFX	S.M. CAP	50V	100nF
C3019	ECUV1H104ZFX	S.M. CAP	50V	100nF
C3020	ECUV1H104ZFX	S.M. CAP	50V	100nF
C3021	ECA1CM331B	ELECT	16V	330µF
C3022	ECA1CM102B	ELECT	16V	1000µF
C3023	ECA1HM100GB	ELECT	50V	10µF
C3024	ECA1HM2R2GB	ELECT	50V	2.2µF
C3025	ECA1CM470GB	ELECT	16V	47µF
C3027	ECJ2VF1H104Z	ELECT	350V	100nF
C3028	ECUV1H470JRX	S.M. CAP	50V	47pF
C3120	ECUV1H103KBX	S.M. CAP	50V	10nF
C3122	ECUV1H102KBX	S.M. CAP	50V	1nF
C3123	ECUV1H103KBX	S.M. CAP	50V	10nF
C3124	ECUV1H102KBX	S.M. CAP	50V	1nF
C3255	ECA1HM4R7GB	ELECT	50V	4.7µF
C3256	ECA1HM4R7GB	ELECT	50V	4.7µF
C3281	ECKC1H561J	CERAMIC	50V	560pF
C3283	ECKC1H561J	CERAMIC	50V	560pF
C3351	ECA1CM221GB	ELECT	16V	220µF
C3401	ECEA1HKA100	ELECT	50V	10pF
C3402	ECUV1H561JCX	S.M. CAP	50V	560pF
C3403	ECUV1H561JCX	S.M. CAP	50V	560pF
C3404	ECUV1H561JCX	S.M. CAP	50V	560pF
C3405	ECUV1H561JCX	S.M. CAP	50V	560pF
C3406	ECUV1H561JCX	S.M. CAP	50V	560pF
C3407	ECUV1H561JCX	S.M. CAP	50V	560pF
C3408	ECUV1H561JCX	S.M. CAP	50V	560pF
C3409	ECEA1HKA4R7	ELECT	50V	4.7µF
C3410	ECEA1HKA100	ELECT	50V	10pF
C3411	ECUV1H561JCX	S.M. CAP	50V	560pF
C3412	ECEA1HKA4R7	ELECT	50V	4.7µF
C3413	ECUV1H102JCX	S.M. CAP	50V	1nF
C3414	ECEA1HKA100	ELECT	50V	10pF
C3415	ECEA1HKA100	ELECT	50V	10pF
C3416	ECEA1HKA4R7	ELECT	50V	4.7µF
C3417	ECEA1HKA100	ELECT	50V	10pF
C3418	ECEA1HKA100	ELECT	50V	10pF

Cct Ref	Parts Number	Description		
C3419	ECUV1H561JCX	S.M. CAP	50V	560pF
C3420	ECUV1H561JCX	S.M. CAP	50V	560pF
C3421	ECUV1H561JCX	S.M. CAP	50V	560pF
C3422	ECUV1H561JCX	S.M. CAP	50V	560pF
C3423	ECUV1H561JCX	S.M. CAP	50V	560pF
C3424	ECUV1H561JCX	S.M. CAP	50V	560pF
C3425	ECUV1H561JCX	S.M. CAP	50V	560pF
C3426	ECUV1H561JCX	S.M. CAP	50V	560pF
C3427	ECUV1H102JCX	S.M. CAP	50V	1nF
C3428	ECEA1HKA4R7	ELECT	50V	4.7µF
C3429	ECEA1CKA220	ELECT	16V	22µF
C3430	ECEA1HKA4R7	ELECT	50V	4.7µF
C3431	ECEA1CN470	ELECT	16V	47µF
C3432	ECUV1H104ZFX	S.M. CAP	50V	100nF
C3433	ECA1CM221GB	ELECT	16V	220µF
C3434	ECUV1H561JCX	S.M. CAP	50V	560pF
C3435	ECEA1HKA100	ELECT	50V	10pF
C3436	ECUV1H561JCX	S.M. CAP	50V	560pF
C3437	ECUV1H561JCX	S.M. CAP	50V	560pF
C3438	ECEA1HKA4R7	ELECT	50V	4.7µF
C3439	ECUV1H561JCX	S.M. CAP	50V	560pF
C3440	ECUV1H561JCX	S.M. CAP	50V	560pF
C3441	ECEA1HKA100	ELECT	50V	10pF
C3442	ECUV1H561JCX	S.M. CAP	50V	560pF
C3443	ECUV1H561JCX	S.M. CAP	50V	560pF
C3444	ECEA1HKA4R7	ELECT	50V	4.7µF
C3445	ECUV1H102JCX	S.M. CAP	50V	1nF
C3446	ECEA1HKA4R7	ELECT	50V	4.7µF
C3447	ECUV1H561JCX	S.M. CAP	50V	560pF
C3460	ECUV1H561JCX	S.M. CAP	50V	560pF
C3461	ECUV1H561JCX	S.M. CAP	50V	560pF
C3496	ECUV1H561JCX	S.M. CAP	50V	560pF
C3497	ECUV1H561JCX	S.M. CAP	50V	560pF
C3498	ECUV1H561JCX	S.M. CAP	50V	560pF
C3802	ECA1CM100GB	ELECT	16V	10µF
C3803	ECA1EM100GB	ELECT	25V	0.1µF
C3804	ECUV1H104ZFX	S.M. CAP	50V	100nF
C3805	ECUV1H224ZFX	S.M. CAP	50V	220nF
C3806	ECA1HM101GB	ELECT	50V	100µF
C3807	ECA1HM100GB	ELECT	50V	10µF
C3808	ECA1CM470GB	ELECT	16V	47µF
C3814	ECA1HM010GB	ELECT	50V	1µF
C3816	ECA1CM471GB	ELECT	16V	470µF
C3817	ECA1CM221GB	ELECT	16V	220µF
C3818	ECUV1H103KBX	S.M. CAP	50V	10nF
C3819	ECA1HM010GB	ELECT	50V	1µF
C3821	ECA1HM010GB	ELECT	50V	1µF
C3823	ECUV1H104ZFX	S.M. CAP	50V	100nF
C3824	ECUV1H103KBX	S.M. CAP	50V	10nF
C3825	ECJ2VB1C224K	ELECT	350V	220nF
C3826	ECUV1H103KBX	S.M. CAP	50V	10nF
TERMINALS AND LINKS				
JK2403	TJB8E014	RCA TERMINAL (2P)		
JK3281	TJB8E017	AV TERMINAL		
JK3401	1364-21-21	SCART SOCKET		
JK3402	1364-21-21	SCART SOCKET		
JK3403	1364-21-21	SCART SOCKET		
R847	TSF19252	FS LINK		
R848	TSF19402	FS LINK		
SWITCHES				
S840	ESB92S11B	SWITCH		
S1071	EVQ23405R	SWITCH		
S1072	EVQ23405R	SWITCH		
S1073	EVQ23405R	SWITCH		
S1074	EVQ23405R	SWITCH		
S1075	EVQ23405R	SWITCH		

Cct Ref	Parts Number	Description			
DIFFERENCES FOR MODEL TX-W28D5F/P					
MECHANICAL PARTS					
13	TKU8E00410	BACK COVER			
14	W66EHK51X81	C.R.T.			
15	VP17243	C.R.T. FIXING SCREW			
16	TKY8E340	CABINET			
17	TMW8E032	CONTROL BRACKET			
18	TNPA1014AB	D P.C.B.			
19	TXFLK01DAG	DEGAUSS COIL			
20	TNPH0176AT	E P.C.B.			
21	TNPA1068AC	F P.C.B.			
22	TKP8E1245	LEFT PANEL			
23	TNPA1048AB	M P.C.B.			
24	TQF8E2756	MODEL LABEL			
25	TKK8E035	REFLECTOR (L)			
26	TKK8E034	REFLECTOR (R)			
27	TKP8E1246	RIGHT PANEL			
28	TNPA1353AB	Y P.C.B.			
MISCELLANEOUS COMPONENTS					
	TKN8E009	TEXTILE			
	TKP8E1247-A	SPEAKER GRILLE			
	TPC8E4702	OUTER CARTON			
	TPD8E669	CUSHION TOP			
	TPD8E670	CUSHION BOTTOM			
	TPD8E678	SPACER CUSHION (R)			
	TPD8E679	SPACER CUSHION (L)			
I.C.s					
IC1102	X24CWH0502NP	EAROM *			
DIODES					
D561	1SS254T-77	DIODE			
D565	MTZJT-7736A	DIODE			
D566	MA165TA5	DIODE			
TRANSISTORS					
Q846	BC547B/126	TRANSISTOR			
Q847	BC557B/126	TRANSISTOR			
Q848	BC547B/126	TRANSISTOR			
Q853	BC557C/126	TRANSISTOR			
Q854	BC557C/126	TRANSISTOR			
TRANSFORMERS					
T551	ZTFM05001A	F.B.T.			
COILS					
L363	TLT082K991R	COIL			
L554	EXCELD8R35V	COIL			
FILTERS					
L840	ELF18D850C	LINE FILTER			
L842	ELF18D850C	LINE FILTER			
RESISTORS					
C3827	ERJ6GEY0R00	S.M.CARB	0.1W	5%	0
R251	ERJ6GEYJ221	S.M.CARB	0.1W	5%	220
R254	ERJ6GEYJ221	S.M.CARB	0.1W	5%	220
R257	ERJ6GEYJ471	S.M.CARB	0.1W	5%	470
R259	ERJ6GEYJ471	S.M.CARB	0.1W	5%	470
R350	ERQ12AJ151P	FUSIBLE	0.5W	5%	150
R356	ERJ6GEYJ181	S.M.CARB	0.1W	5%	180
R358	ERC12GK821C	SOLID	0.5W	5%	820
R366	ERJ6GEYJ181	S.M.CARB	0.1W	5%	180
R368	ERC12GK821C	SOLID	0.5W	5%	820
R370	ERQ1CKPR68	FUSIBLE	1W	10%	R68
R376	ERJ6GEYJ181	S.M.CARB	0.1W	5%	180
R378	ERC12GK821C	SOLID	0.5W	5%	820
R394	ERJ6ENF7500	S.M.CARB	0.1W	5%	75

Cct Ref	Parts Number	Description				
R395	ERJ6ENF5900	S.M.CARB	0.1W	5%	90	☒
R396	ERJ6ENF7500	S.M.CARB	0.1W	5%	75	☒
R397	ERJ6ENF5900	S.M.CARB	0.1W	5%	90	☒
R398	ERJ6ENF7500	S.M.CARB	0.1W	5%	75	☒
R399	ERJ6ENF5900	S.M.CARB	0.1W	5%	90	☒
R419	ERG3FJ331	METAL	3W	5%	330	☒ ⚠
R441	ERJ6GEYJ363	S.M.CARB	0.5W	5%	36K	☒
R452	ERDS1TJ2R7	CARBON	0.5W	5%	2R7	☒
R457	ERJ6GEYJ622	S.M.CARB	0.1W	5%	6K2	☒
R505	ERG3FJ390H	METAL	3W	5%	39	☒ ⚠
R556	ERDS1TJ333	CARBON	0.5W	5%	33K	☒
R558	ERDS1TJ393	CARBON	0.5W	5%	39K	☒
R560	ERD25TJ123	CARBON	0.25W	5%	12K	☒
R561	ERD25TJ123	CARBON	0.25W	5%	12K	☒
R562	ERD25TJ223	CARBON	0.25W	5%	22K	☒
R563	ERD25TJ223	CARBON	0.25W	5%	22K	☒
R570	ERD25TJ103	CARBON	0.25W	5%	10K	☒
R579	ERD25TJ274	CARBON	0.25W	5%	270K	☒
R580	ERD25TJ563	CARBON	0.25W	5%	56K	☒
R581	ERD25TJ104	CARBON	0.25W	5%	100K	☒
R582	ERD25TJ225	CARBON	0.25W	5%	2M2	☒
R583	ERD25TJ225	CARBON	0.25W	5%	2M2	☒
R588	ERD25TJ332	CARBON	0.25W	5%	3K3	☒
R663	ERJ6GEYJ334	S.M.CARB	0.1W	5%	330K	☒
R664	ERJ6GEYJ912	S.M.CARB	0.1W	5%	9K1	☒
R665	ERJ6GEYJ472	S.M.CARB	0.1W	5%	4K7	☒
R667	ERJ6GEYJ683	S.M.CARB	0.1W	5%	68K	☒
R680	ERJ6GEYJ473	S.M.CARB	0.1W	5%	47K	☒
R701	ERX3FJ2R7H	METAL	3W	5%	2R7	☒
R703	ERD25TJ393	CARBON	0.25W	5%	39K	☒
R806	ERD25TJ101	CARBON	0.25W	5%	100	☒
R810	ERD25TJ223	CARBON	0.25W	5%	22K	☒
R811	ERD25TJ391	CARBON	0.25W	5%	390	☒
R818	ERD25TJ511	CARBON	0.25W	5%	510	☒
R870	ERD25TJ101	CARBON	0.25W	5%	100	☒
R876	ERD25TJ562	CARBON	0.25W	5%	5K6	☒
R883	ERD25TJ103	CARBON	0.25W	5%	10K	☒
R889	ERD25TJ392	CARBON	0.25W	5%	3K9	☒
R891	ERD25TJ103	CARBON	0.25W	5%	10K	☒
R892	ERD25TJ222	CARBON	0.25W	5%	2K2	☒
R897	ERD25TJ183	CARBON	0.25W	5%	18K	☒
R906	ERJ6GEYJ563	S.M.CARB	0.1W	5%	56K	☒
R907	ERJ6GEYJ822	S.M.CARB	0.1W	5%	8K2	☒
R909	ERJ6GEYJ102	S.M.CARB	0.1W	5%	1K	☒
R910	ERJ6GEYJ221	S.M.CARB	0.1W	5%	220	☒
R914	ERJ6GEYJ222	S.M.CARB	0.1W	5%	2K2	☒
R924	ERDS1FYJ390	CARBON	0.5W	5%	39	☒ ⚠
CAPACITORS						
C386	ECKC3D152J	CERAMIC	2KV		1.5nF	⚠
C405	ECA1EM102GB	ELECT	25V		100µF	
C559	ECKC2H103J	CERAMIC	50V		10nF	⚠
C564	ECKC1H103JB	CERAMIC	50V		10nF	
C572	ECWH20622JVB	FILM	200V		6.2nF	
C573	ECQF4153JZH	FILM	400V		1.5nF	⚠
C574	ECWF4105JBB	FILM	400V		1µF	
C575	ECWF4564JBB	FILM	400V		560nF	
C811	ECQB1H104J	FILM	50V		100nF	
C840	ECQE2A474MWB	FILM	100V		470nF	
C841	ECQE2A474MWB	FILM	100V		470nF	
C843	ECQE2A474MWB	FILM	100V		470nF	
C852	ECKC3D222JB	CERAMIC	2KV		2200pF	⚠
C856	ECA1EM332E	ELECT	25V		3300µF	
C906	ECUV1H681JCX	S.M. CAP	50V		680pF	
C1663	ECUV1H560JCX	S.M. CAP	50V		56pF	
C1695	ECUV1H221JCX	S.M. CAP	50V		220pF	

Cct Ref	Parts Number	Description	
DIFFERENCES FOR MODEL TX-W32D5F/P			
MECHANICAL PARTS			
13	TKU8E00400	BACK COVER	⚠
14	W76LNR585X05	C.R.T.	⚠
15	VP19151	C.R.T. FIXING SCREW	
16	TKY8E330	CABINET	⚠
17	TMW8E031	CONTROL BRACKET	
18	TNPA0876AB	D P.C.B.	⚠
19	TLK8E05123	DEGAUSS COIL	⚠
20	TNPH0176AU	E P.C.B.	⚠
21	TNPA1068AA	F P.C.B.	⚠
22	TKP8E1244	LEFT PANEL	
23	TNPA1048AA	M P.C.B.	⚠
24	TQF8E2757	MODEL LABEL	⚠
25	TKK8E033-1	REFLECTOR (L)	
26	TKK8E032-1	REFLECTOR (R)	
27	TKP8E1238	RIGHT PANEL	
28	TNPA1353AA	Y P.C.B.	⚠
MISCELLANEOUS COMPONENTS			
	TKN8E008	TEXTILE	
	TKP8E1242	SPEAKER GRILLE	
	TLK8E05124	GEOMAGNETIC COIL	⚠
	TPC8E4700	OUTER CARTON	
	TPD8E667	CUSHION TOP	
	TPD8E668	CUSHION BOTTOM	
	TPD8E676	CUSHION SPACER (R)	
	TPD8E677	CUSHION SPACER (L)	
I.C.s			
IC1102	X24CWH0502PP	EAROM *	
IC1901	LA6515	EARTH CORRECTION	
IC3901	AN5422K	DYNAMIC FOCUS	
DIODES			
D373	MTZJT-7715A	DIODE	
D374	MTZJT-7715A	DIODE	
D375	MTZJT-7715A	DIODE	
D703	MA29TA5	DIODE	
D3901	MTZJT-779.1C	DIODE	
D3907	ERA22-06V3	DIODE	
D3908	ERA22-06V3	DIODE	
D3909	MA165TA5	DIODE	
D3910	RP1HLFA5	DIODE	
D3911	RP1HLFA5	DIODE	
D3912	1SS254T-77	DIODE	
D3915	MTZJT-7710D	DIODE	
D3917	MA165TA5	DIODE	
TRANSISTORS			
Q846	BC847B	TRANSISTOR	
Q847	BC857B	TRANSISTOR	
Q848	BC847B	TRANSISTOR	
Q853	BC857C	TRANSISTOR	
Q854	BC857C	TRANSISTOR	
Q1901	BC847B	TRANSISTOR	
Q3901	BC847B	TRANSISTOR	
Q3902	BC847B	TRANSISTOR	
Q3903	BC847B	TRANSISTOR	
Q3904	BC857B	TRANSISTOR	
Q3905	2SK1006RF122	TRANSISTOR	
Q3906	2SC4572RB	TRANSISTOR	
Q3907	BC847B	TRANSISTOR	
Q3908	BC847B	TRANSISTOR	
Q3911	BC847B	TRANSISTOR	
Q3912	BC847B	TRANSISTOR	

Cct Ref	Parts Number	Description
TRANSFORMERS		
T551	ZTFL77002A	F.B.T.
T3901	ETF18L37B	TRANSFORMER
COILS		
J361	EXCELSA39V	COIL
L363	TLT120K991R	COIL
L383	EXCELSA35T	COIL
L554	EXCELSA35T	COIL
L555	EXCELDLR35V	COIL
L557	EXCELDLR35C	COIL
L840	ELF18D856A	COIL
L842	ELF18D856A	COIL
L1901	EXCELDLR25V	COIL
L3901	EXCELSA35T	COIL
L3902	ELC08D182E	COIL
RESISTORS		
JA16	ERJ8GEY0R00	S.M.CARB .125W 5% 0
R251	ERJ6GEYJ681	S.M.CARB 0.1W 5% 680
R254	ERJ6GEYJ681	S.M.CARB 0.1W 5% 680
R257	ERJ6GEY0R00	S.M.CARB 0.1W 5% 0
R259	ERJ6GEY0R00	S.M.CARB 0.1W 5% 0
R350	ERQ12AJ331P	METAL .125W 5% 330
R356	ERJ6GEY0R00	S.M.CARB 0.1W 5% 0
R358	ERC12GK471C	SOLID 0.5W 5% 470
R366	ERJ6GEY0R00	S.M.CARB 0.1W 5% 0
R368	ERC12GK471C	SOLID 0.5W 5% 470
R370	ERQ2CJP2R2	METAL 2W 5% 2R2
R376	ERJ6GEY0R00	S.M.CARB 0.1W 5% 0
R378	ERC12GK471C	SOLID 0.5W 5% 470
R394	ERJ6ENF1021	S.M. CAR 0.1W 5% 1K
R395	ERJ6ENF2370	S.M. CAR 0.1W 5% 37
R396	ERJ6ENF1021	S.M. CAR 0.1W 5% 1K
R397	ERJ6ENF2370	S.M. CAR 0.1W 5% 37
R398	ERJ6ENF1021	S.M. CAR 0.1W 5% 1K
R399	ERJ6ENF2370	S.M. CAR 0.1W 5% 37
R419	ERG3FJ471	METAL 3W 5% 470
R441	ERJ6GEYJ393	S.M.CARB 0.1W 5% 39K
R443	ERJ6GEYJ222	S.M.CARB 0.1W 5% 2K2
R452	ERDS1TJ3R3	CARBON 0.5W 5% 3R3
R457	ERJ6GEYJ682	S.M.CARB 0.1W 5% 6K8
R554	ERX3FJR39H	METAL 3W 5% R39
R556	ERDS1TJ223	CARBON 0.5W 5% 22K
R558	ERDS1TJ273	CARBON 0.5W 5% 27K
R560	ERJ6GEYJ123	S.M.CARB 0.1W 5% 12K
R562	ERJ6GEYJ273	S.M.CARB 0.1W 5% 27K
R570	ERJ6GEYJ103	S.M.CARB 0.1W 5% 10K
R579	ERJ6GEYJ274	S.M.CARB 0.1W 5% 270K
R580	ERJ6GEYJ563	S.M.CARB 0.1W 5% 56K
R581	ERJ6GEYJ104	S.M.CARB 0.1W 5% 100K
R582	ERJ6GEYJ225	S.M.CARB 0.1W 5% 2M2
R583	ERJ6GEYJ225	S.M.CARB 0.1W 5% 2M2
R588	ERJ6GEY0R00	S.M.CARB 0.1W 5% 0
R663	ERJ6GEYJ394	S.M.CARB 0.1W 5% 390K
R664	ERJ6GEYJ682	S.M.CARB 0.1W 5% 6K8
R667	ERJ6GEYJ473	S.M.CARB 0.1W 5% 47K
R680	ERJ6GEYJ273	S.M.CARB 0.1W 5% 27K
R701	ERQ1CJP5R6	METAL 1W 5% 5R6
R703	ERJ6GEYJ103	S.M.CARB 0.1W 5% 10K
R705	ERJ6GEYJ472	S.M.CARB 0.1W 5% 4K7
R806	ERJ6GEYJ101	S.M.CARB 0.1W 5% 100
R810	ERJ6GEYJ223	S.M.CARB 0.1W 5% 22K
R811	ERJ6GEYJ391	S.M.CARB 0.1W 5% 390
R818	ERJ6GEYJ511	S.M.CARB 0.1W 5% 510
R870	ERJ6GEYJ101	S.M.CARB 0.1W 5% 100
R872	ERJ6GEY0R00	S.M.CARB 0.1W 5% 0

Cct Ref	Parts Number	Description
R876	ERJ6GEYJ562	S.M.CARB 0.1W 5% 5K6
R883	ERJ6GEYJ103	S.M.CARB 0.1W 5% 10K
R889	ERJ6GEYJ392	S.M.CARB 0.1W 5% 3K9
R891	ERJ6GEYJ103	S.M.CARB 0.1W 5% 10K
R892	ERJ6GEYJ222	S.M.CARB 0.1W 5% 2K2
R894	ERJ6GEY0R00	S.M.CARB 0.1W 5% 0
R897	ERJ6GEYJ183	S.M.CARB 0.1W 5% 18K
R899	ERJ6GEY0R00	S.M.CARB 0.1W 5% 0
R906	ERJ6GEYJ153	S.M.CARB 0.1W 5% 15K
R907	ERJ6GEYJ222	S.M.CARB 0.1W 5% 2K2
R909	ERJ6GEYJ222	S.M.CARB 0.1W 5% 2K2
R910	ERJ6GEYJ101	S.M.CARB 0.1W 5% 100
R914	ERJ6GEYJ202	S.M.CARB 0.1W 5% 2K
R924	ERDS1FYJ330	CARBON 0.5W 5% 33
R1112	ERJ6GEYJ103	S.M.CARB 0.1W 5% 10K
R1901	ERDS1TJ100	CARBON 0.5W 5% 10
R1902	ERDS1TJ100	CARBON 0.5W 5% 10
R1903	ERJ6GEYJ683	S.M.CARB 0.1W 5% 68K
R1904	ERJ6GEYJ334	S.M.CARB 0.1W 5% 330K
R1905	ERJ6GEYJ683	S.M.CARB 0.1W 5% 68K
R1906	ERJ6GEYJ563	S.M.CARB 0.1W 5% 56K
R1907	ERJ6GEY0R00	S.M.CARB 0.1W 5% 0
R1908	ERJ6GEYJ472	S.M.CARB 0.1W 5% 4K7
R1909	ERJ6GEYJ362	S.M. CAR 0.1W 5% 3K6
R1910	ERJ6GEYJ222	S.M.CARB 0.1W 5% 2K2
R1911	ERJ6GEY0R00	S.M.CARB 0.1W 5% 0
R1912	ERJ6GEYJ103	S.M.CARB 0.1W 5% 10K
R1913	ERJ6GEYJ222	S.M.CARB 0.1W 5% 2K2
R3918	ERJ6GEYJ272	S.M.CARB 0.1W 5% 2K7
R3919	ERJ6GEYJ273	S.M.CARB 0.1W 5% 27K
R3920	ERJ6GEYJ103	S.M.CARB 0.1W 5% 10K
R3921	ERJ6GEYJ153	S.M.CARB 0.1W 5% 15K
R3922	EVMEASA00B53	CONTROL 5K
R3923	ERJ6GEYJ562	S.M.CARB 0.1W 5% 5K6
R3925	ERO25CKF1272	METAL 0.25W 5% 2K7
R3926	ERO25CKF3242	METAL 0.25W 5% 2K4
R3927	ERD25TJ103	CARBON 0.25W 5% 10K
R3928	ERDS1FJ103	CARBON 0.5W 5% 10K
R3929	ERJ6GEYJ472	S.M.CARB 0.1W 5% 4K7
R3930	ERDS1FJ103	CARBON 0.5W 5% 10K
R3931	ERJ6GEYJ561	S.M.CARB 0.1W 5% 560
R3932	ERJ6GEYJ103	S.M.CARB 0.1W 5% 10K
R3933	ERJ6GEYJ103	S.M.CARB 0.1W 5% 10K
R3934	ERJ6GEYJ564	S.M.CARB 0.1W 5% 560K
R3935	ERDS1FJ561	CARBON 0.5W 5% 56
R3936	ERJ6GEYJ820	S.M.CARB 0.1W 5% 82
R3938	EVMEASA00B53	CONTROL 5K
R3939	ERJ6GEYJ472	S.M.CARB 0.1W 5% 4K7
R3941	ERJ6GEYJ101	S.M.CARB 0.1W 5% 100
R3942	ERD25TJ123	CARBON 0.25W 5% 12K
R3943	ERDS1TJ104	CARBON 0.5W 5% 100K
R3944	ERJ6GEYJ125	S.M. CAR 0.1W 5% 1M2
R3945	ERJ6GEYJ125	S.M. CAR 0.1W 5% 1M2
R3946	ERJ6GEYJ104	S.M.CARB 0.1W 5% 100K
R3947	ERG2FJ123H	METAL 2W 5% 12K
R3949	ERDS1FJ332	CARBON 0.5W 5% 3K3
R3950	ERG3FJ102H	METAL 3W 5% 1K
R3951	ERD25TJ334	CARBON 0.25W 5% 330K
R3952	ERJ6GEYJ101	S.M.CARB 0.1W 5% 100
R3953	ERG2FJ100H	METAL 2W 5% 10
R3954	ERD25TJ473	CARBON 0.25W 5% 47K
R3955	ERJ6GEYJ123	S.M.CARB 0.1W 5% 12K
R3956	ERD25TJ104	CARBON 0.25W 5% 100K
R3957	ERD25TJ104	CARBON 0.25W 5% 100K
R3958	ERD25TJ104	CARBON 0.25W 5% 100K
R3959	ERD25TJ104	CARBON 0.25W 5% 100K

Cct Ref	Parts Number	Description				
R3960	ERJ6GEYJ622	S.M.CARB	0.1W	5%	6K2	🔒
R3961	ERJ6GEYJ272	S.M.CARB	0.1W	5%	2K7	🔒
R3962	ERD25TJ563	CARBON	0.25W	5%	56K	🔒
R3963	ERJ6GEYJ563	S.M.CARB	0.1W	5%	56K	🔒
R3972	ERG2FJ471	METAL	2W	5%	470	🔒
R3973	ERJ6GEYJ102	S.M.CARB	0.1W	5%	1K	🔒
R3974	ERJ6GEYJ102	S.M.CARB	0.1W	5%	1K	🔒
R3975	ERJ6GEYJ102	S.M.CARB	0.1W	5%	1K	🔒
R3976	ERJ6GEYJ102	S.M.CARB	0.1W	5%	1K	🔒
R3978	ERJ6GEY0R00	S.M.CARB	0.1W	5%	0	🔒
R3981	ERQ14AJ220	FUSIBLE	0.25W	5%	22	🔒
R3982	ERJ6GEYJ333	S.M.CARB	0.1W	5%	33K	🔒
R3983	ERJ6GEYJ823	S.M.CARB	0.1W	5%	82K	🔒
R3984	ERJ6GEYJ123	S.M.CARB	0.1W	5%	12K	🔒
R3985	ERJ6GEYJ102	S.M.CARB	0.1W	5%	1K	🔒
R3986	ERJ6GEYJ103	S.M.CARB	0.1W	5%	10K	🔒
R3987	ERJ6GEYJ332	S.M.CARB	0.1W	5%	3K3	🔒
R3988	ERJ6GEYJ684	S.M.CARB	0.1W	5%	680K	🔒
R3989	ERJ6GEYJ221	S.M.CARB	0.1W	5%	220	🔒

CAPACITORS

C386	ECKC3D392J	CERAMIC	2KV		3900pF	🔒
C397	ECKC3D222JB	CERAMIC	2KV		2200pF	🔒
C403	ECQV1H105JZ	FILM	50V		1µF	🔒
C566	ECKC2H222J	CERAMIC	500V		2200pF	🔒
C572	ECWH20562JVB	FILM	200V		5.6nF	🔒
C573	ECQF4103JZH	FILM	400V		10nF	🔒
C574	ECWF4824JBB	FILM	400V		820nF	🔒
C575	ECWF4474JBB	FILM	400V		470nF	🔒
C644	ECQM1H104J	FILM	50V		100nF	🔒
C645	ECQM1H104J	FILM	50V		100nF	🔒
C811	ECQM1H104J	FILM	50V		100nF	🔒
C840	222233510224	FILM	50V		220nF	🔒
C841	222233510224	FILM	50V		220nF	🔒
C843	222233510154	FILM	50V		100µF	🔒
C852	ECKC3D102J	CERAMIC	2KV		1nF	🔒
C856	ECA1EM222GB	ELECT	25V		2200µF	🔒
C906	ECUV1H681KBX	S.M. CAP	50V		680pF	🔒
C1663	ECUV1H820JCX	S.M. CAP	50V		82pF	🔒
C1901	ECQM1H474J	FILM	50V		470nF	🔒
C1902	ECQM1H474J	FILM	50V		470nF	🔒
C1903	ECA1EM470GB	ELECT	25V		47µF	🔒
C1904	ECUV1H103ZFX	S.M. CAP	50V		10nF	🔒
C1905	ECUV1C224KBX	S.M. CAP	16V		220nF	🔒
C3810	ECUV1H103KBX	S.M. CAP	50V		10nF	🔒
C3827	ECUV1H224ZFX	S.M. CAP	50V		220nF	🔒
C3830	ECKC1H561J	CERAMIC	50V		560pF	🔒
C3909	ECQB1H153K	FILM	50V		15nF	🔒
C3910	ECA1HM010GB	ELECT	50V		1µF	🔒
C3911	ECQB1H153K	FILM	50V		15nF	🔒
C3912	ECQM1222JZ	FILM	100V		2.2nF	🔒
C3913	ECQV1H105JZ	FILM	50V		1µF	🔒
C3914	ECA1CM331B	ELECT	16V		330µF	🔒
C3915	ECQB1H103J	FILM	50V		10nF	🔒
C3916	ECQM1H154J	FILM	50V		150nF	🔒
C3917	ECQB1H683K	FILM	50V		68nF	🔒
C3918	ECQB1H222J	FILM	50V		2.2nF	🔒
C3919	ECQB1H333J	FILM	50V		33nF	🔒
C3920	ECQB1H332K	FILM	50V		3.3nF	🔒
C3922	ECKC3A182J	CERAMIC	1KV		1800pF	🔒
C3923	ECEA1HN100UB	ELECT	50V		10µF	🔒
C3924	ECKC3A122J	CERAMIC	1KV		1.2nF	🔒
C3925	ECKC3A151J	CERAMIC	1KV		150pF	🔒
C3926	ECKC3A681J	CERAMIC	1KV		680pF	🔒
C3927	ECA1HM010GB	ELECT	50V		1µF	🔒
C3928	ECQM4223JZW	FILM	400V		22nF	🔒
C3929	ECQM4223JZW	FILM	400V		22nF	🔒

Cct Ref	Parts Number	Description				
C3931	ECKC3D101J	CERAMIC	2KV		100pF	🔒
C3932	ECUV1H103KBX	S.M. CAP	50V		10nF	🔒
C3933	ECKC3A471J	CERAMIC	1KV		470pF	🔒
C3936	ECA2CM330B	ELECT	160V		33µF	🔒
C3937	ECQM1H104J	FILM	50V		100nF	🔒
C3939	ECA1HM3R3GB	ELECT	50V		3.3µF	🔒
C3940	ECA1CMH471B	ELECT	16V		470µF	🔒
C3941	ECA1HMHR47B	ELECT	50V		470µF	🔒
C3942	ECEA1HN010UB	ELECT	50V		1µF	🔒
C3943	ECUV1H101JCX	S.M. CAP	50V		100pF	🔒
C3944	ECQB1H103J	FILM	50V		10nF	🔒
C3945	ECA1HM100GB	ELECT	50V		10µF	🔒
C3946	ECQB1H333J	FILM	50V		33nF	🔒
C3947	ECKC3D102J	CERAMIC	2KV		1nF	🔒
C3948	ECQV1H105JZ	FILM	50V		1µF	🔒
C3955	ECQB1H563K	FILM	50V		56nF	🔒

TERMINALS AND LINKS

R1914	TSF19161	FS LINK				🔒
-------	----------	---------	--	--	--	---

SCHEMATIC DIAGRAMS FOR MODELS

TX-W32D5F /P
TX-W28D5F /P

(EURO - 5 CHASSIS)



IMPORTANT SAFETY NOTICE

Components identified by  mark have special characteristics important for safety. When replacing any of these components, use only manufacturer's specified parts.



NOTE

1. RESISTOR
All resistors are carbon ¼W resistor, unless marked otherwise.
Unit of resistance is OHM (Ω) (k=1,000, M=1,000,000)
2. CAPACITORS
All capacitors are ceramic 50V unless marked otherwise.
Unit of capacitance is μ F unless otherwise stated.
3. COIL
Unit of inductance is μ H, unless otherwise stated.

4. TEST POINT
 Test Point Position

5. EARTH SYMBOL
 Chassis Earth (Cold)
 Line Earth (Hot)

6. VOLTAGE MEASUREMENT
Voltage is measured by a d.c. voltmeter.
Measurement conditions are as follows:
Power source a.c. 220V-240V, 50Hz
Receiving Signal Colour Bar signal (RF)
All customer controls Maximum position

7.
 Indicates the Video signal path
 Indicates the Audio signal path

These schematic diagrams are the latest at time of printing and are subject to change without notice.

REMARKS

- a. Do not touch the hot part, or the hot and cold parts at the same time, as you are liable to a shock hazard.
- b. Do not short circuit the hot and cold circuits as electrical components may be damaged.
- c. Do not connect an instrument, such as an oscilloscope, to the hot and cold circuits simultaneously as this may cause fuse failure. Connect the earth of the instruments to the earth connection of the circuit being measured.
- d. Make sure to disconnect the power plug before removing the chassis.

NOTE

1. The Power Supply Circuit contains a circuit area, which uses a separate power supply to isolate the earth connection. The circuit is defined by HOT and COLD indications in the schematic diagram. All circuits, except the Power Circuit, are COLD.

TX - W32D5F / P

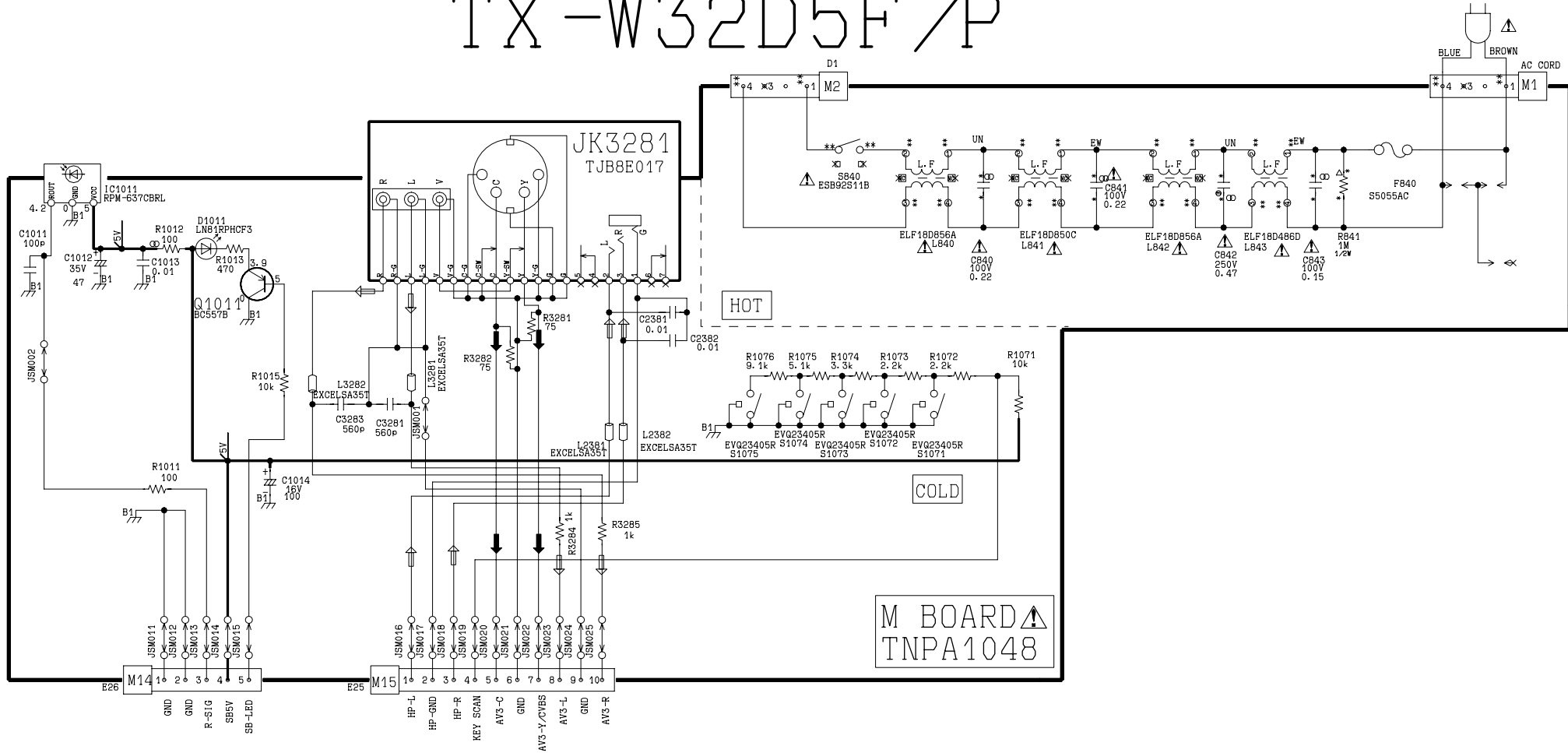

TX-W28D5F/P

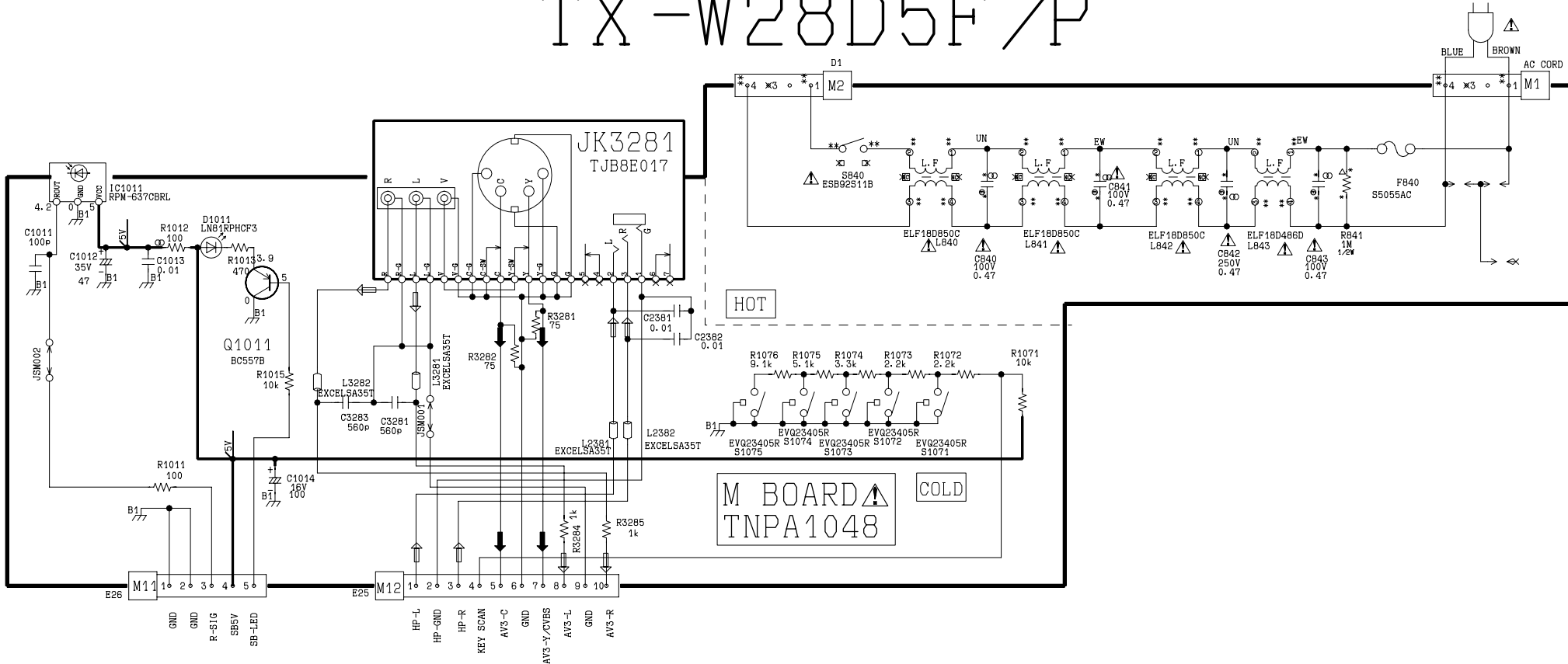

TX-W28D5F/P

E BOARD
TNP0176

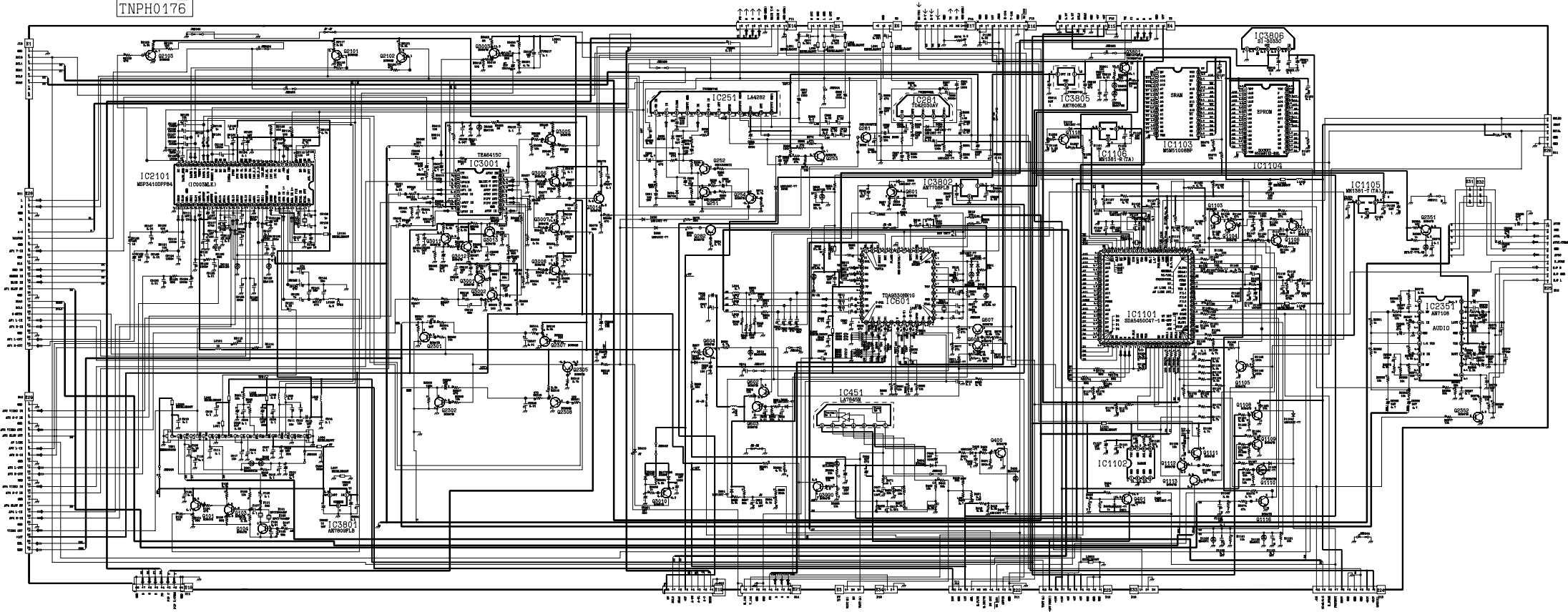

TX-W32D5F/P

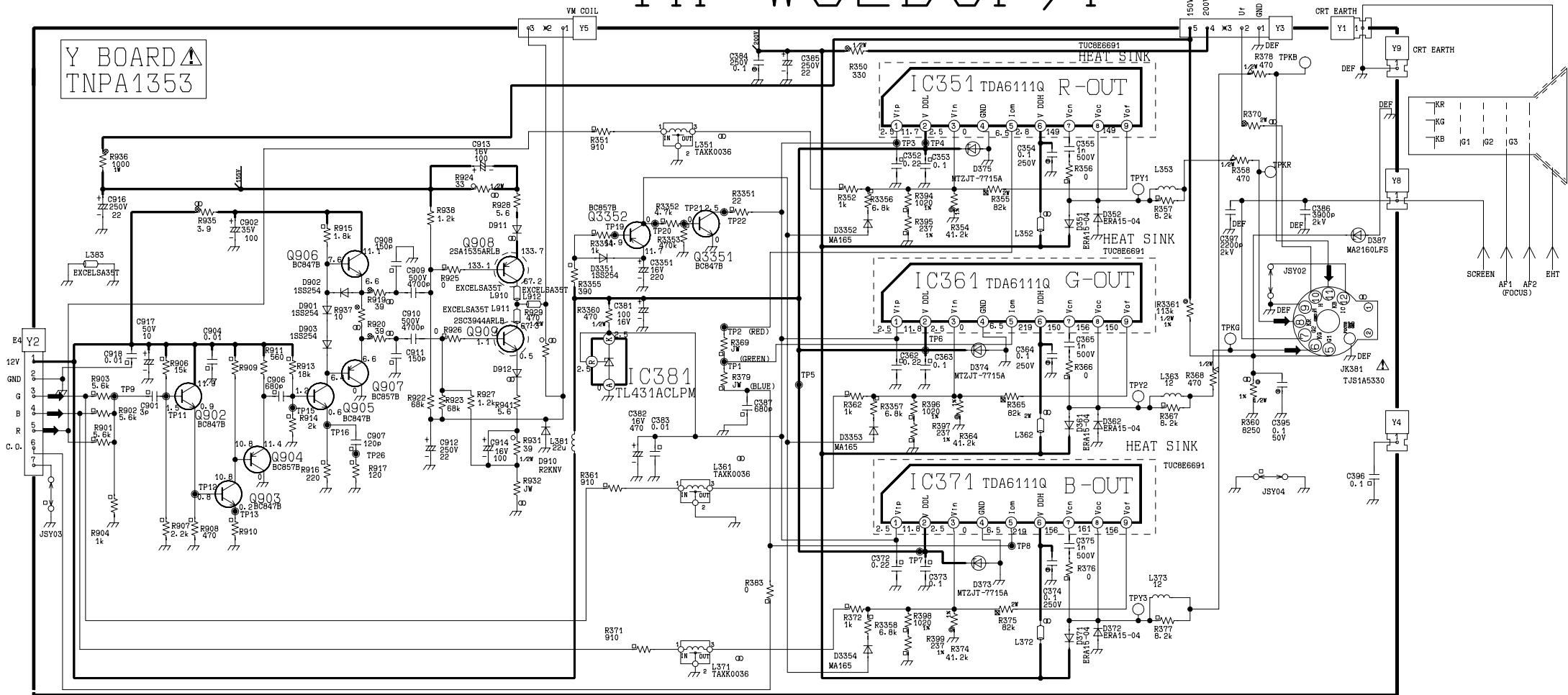

TX-W32D5F/P

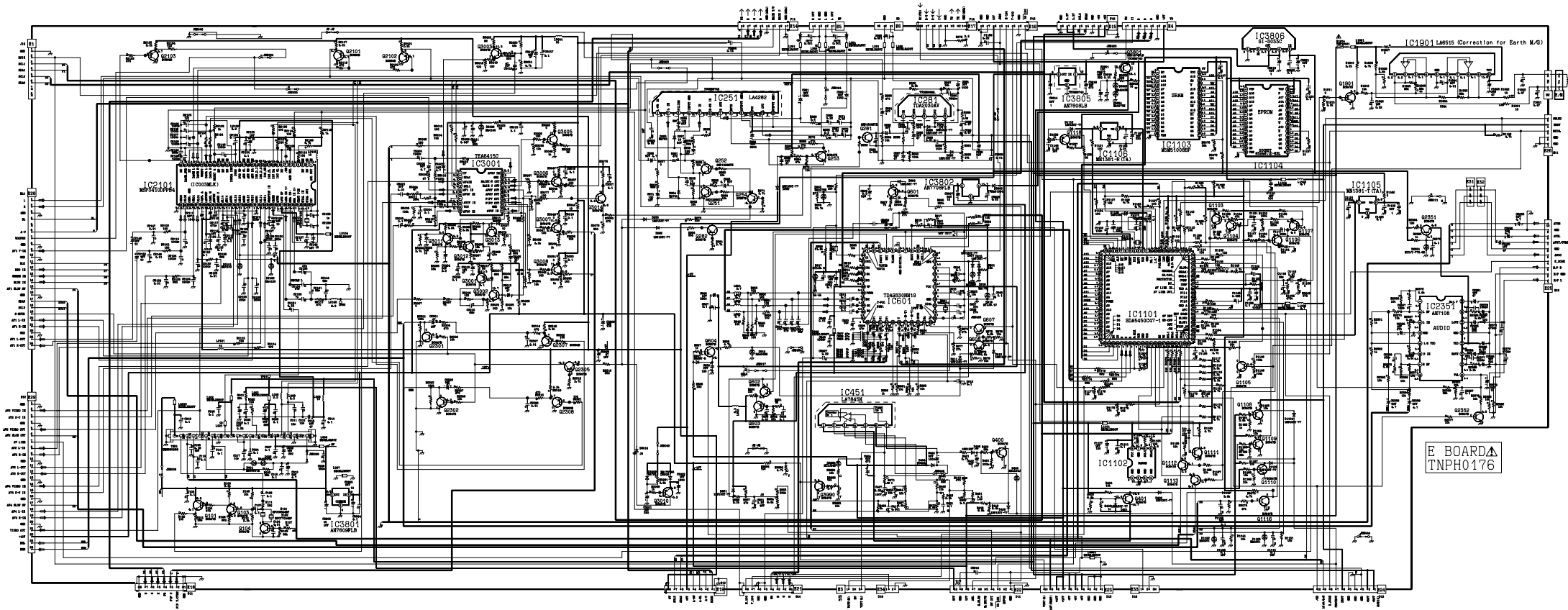

TX -W32D5F/P

D BOARD
TNPA0876

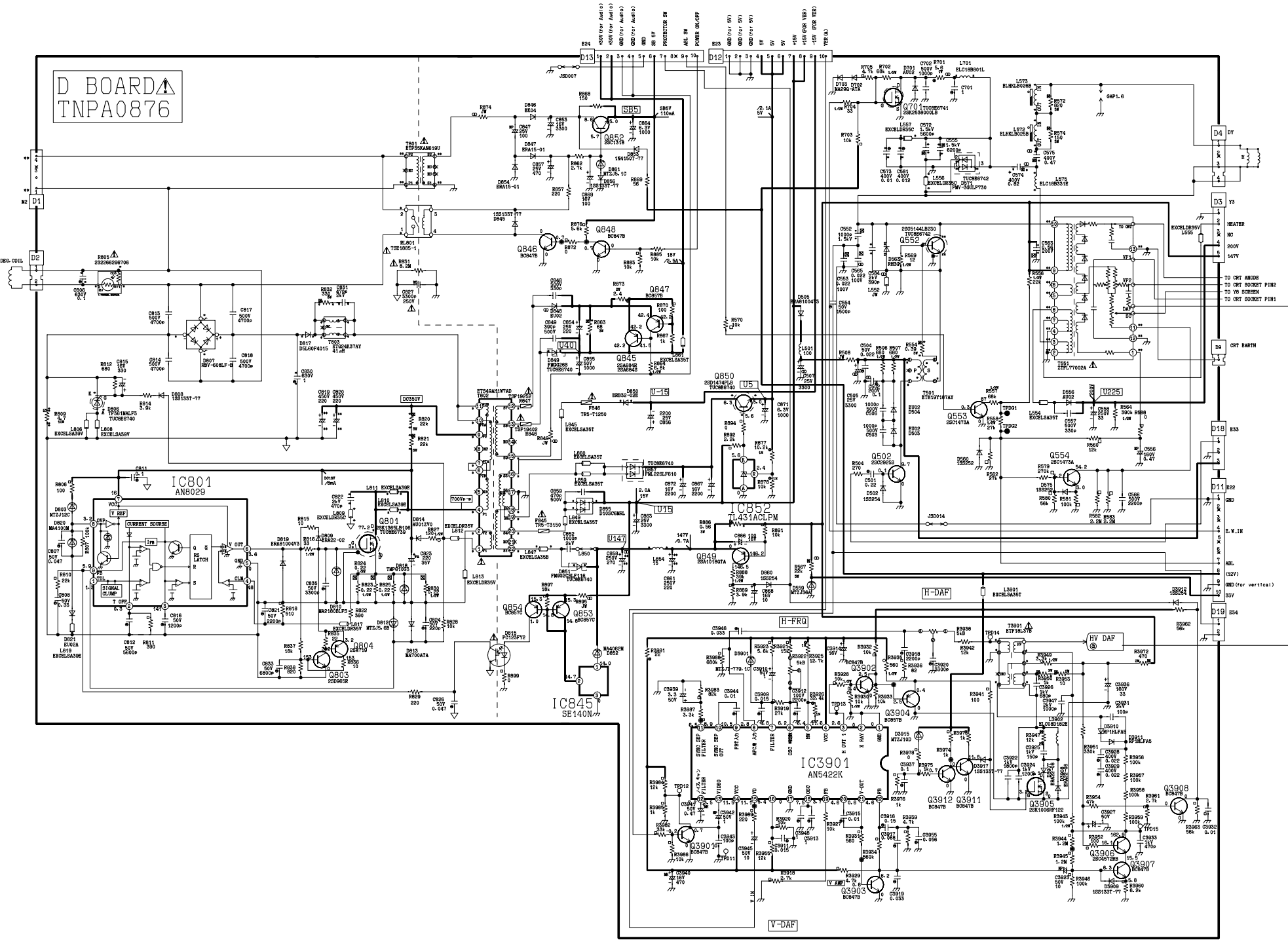

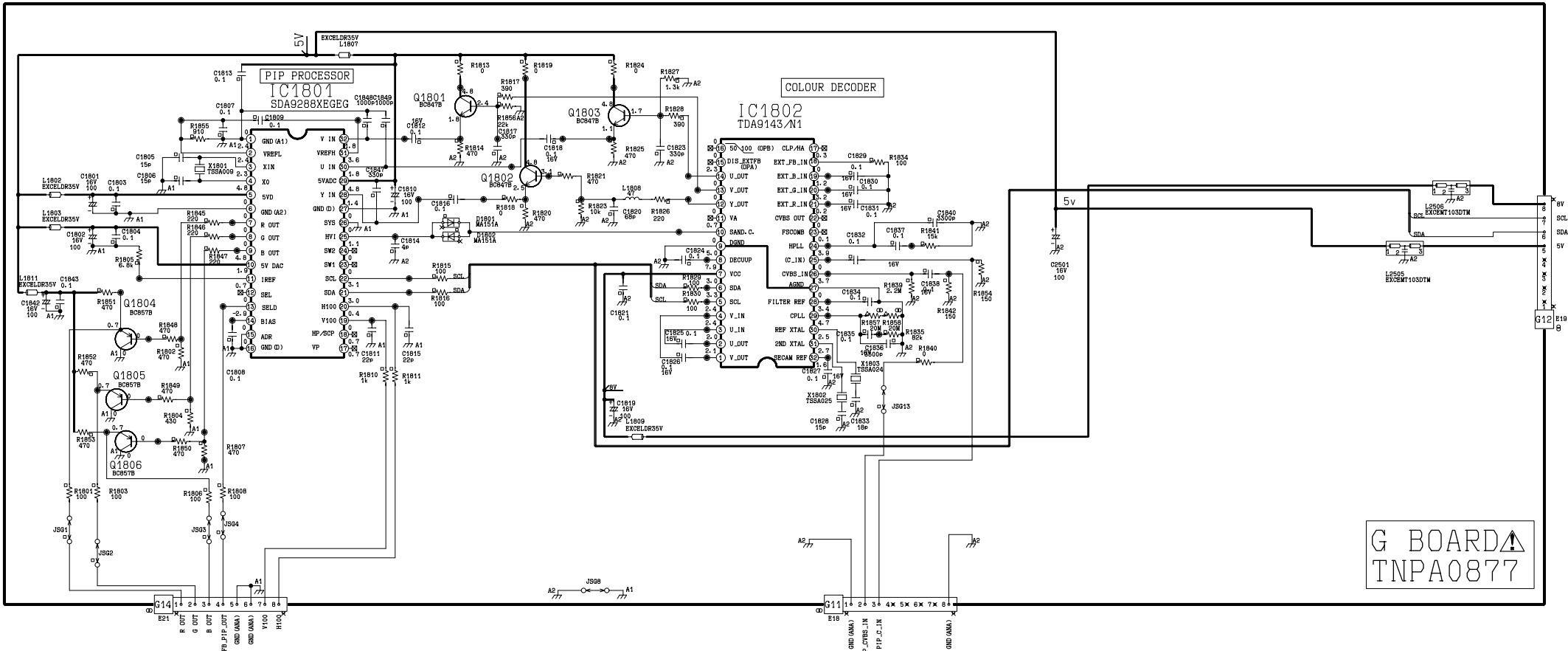

G BOARD
TNPA0877

TX-W28D5F/P

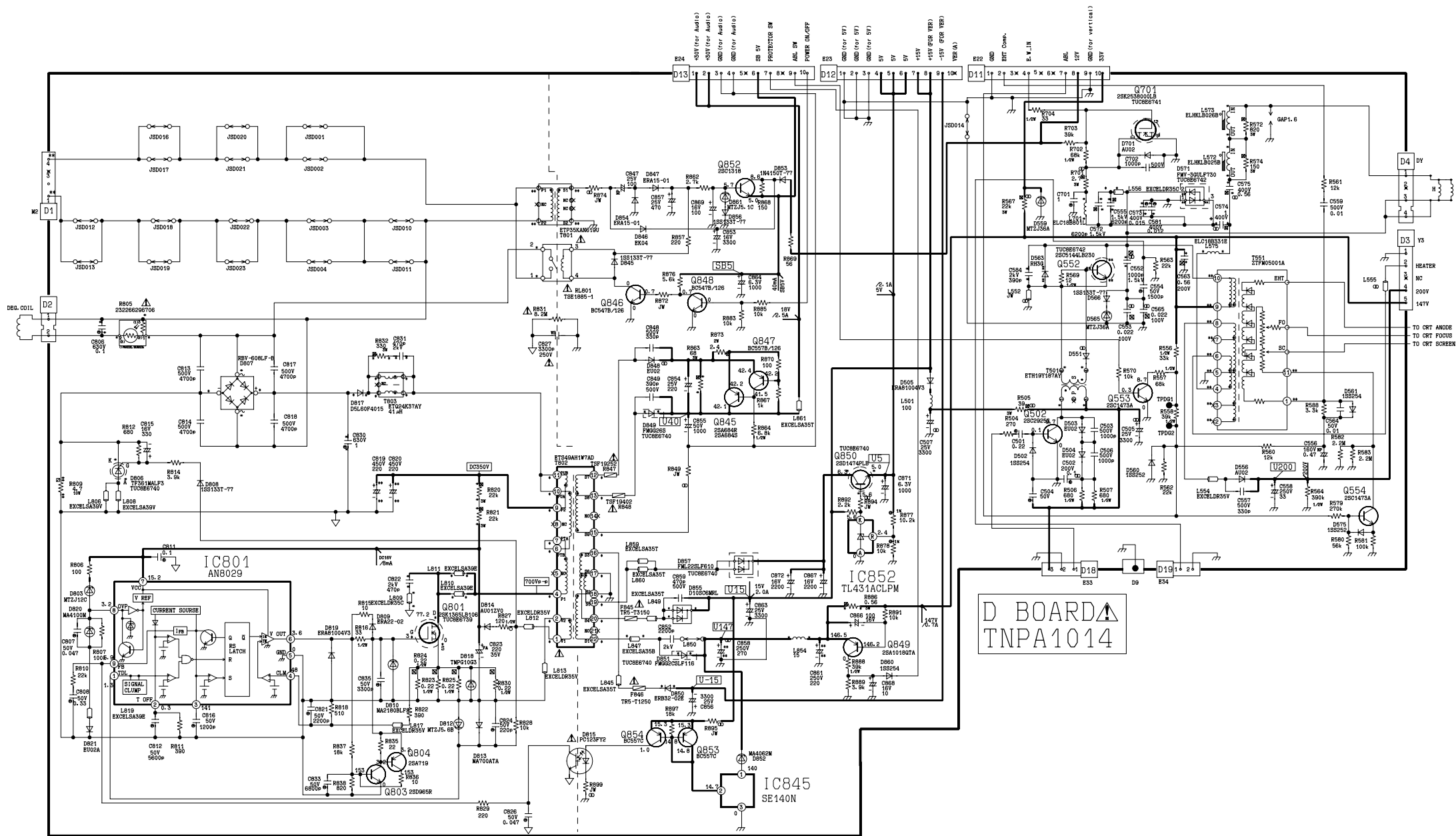

H BOARD
TNPA1047

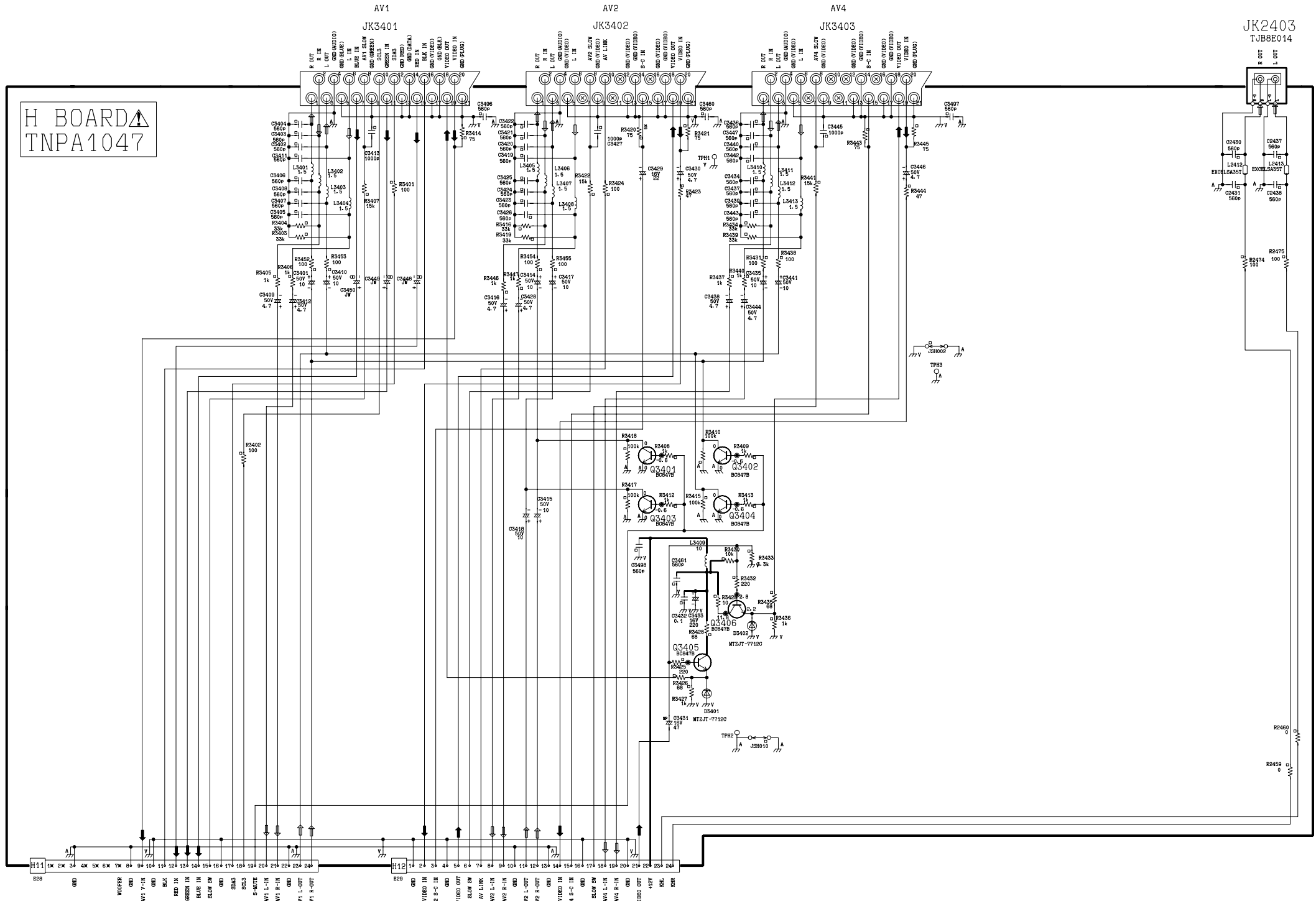

JK2403
TJB8E014

- B28 1K 2K 3K 4K 5K 6K 7K 8K 9K 10K 11K 12K 13K 14K 15K 16K 17K 18K 19K 20K 21K 22K 23K 24K
- AV1 V-IN GND
- AV1 V-SLOW GND
- AV1 S-SLOW GND
- AV1 S-WHITE GND
- AV1 L-IN GND
- AV1 R-IN GND
- AV1 L-OUT GND
- AV1 R-OUT GND
- B29 GND
- AV2 VIDEO IN GND
- AV2 S-C IN GND
- AV2 VIDEO OUT GND
- AV2 SLOW SW GND
- AV2 L-LINK GND
- AV2 L-IN GND
- AV2 R-IN GND
- AV2 L-OUT GND
- AV2 R-OUT GND
- AV4 VIDEO IN GND
- AV4 S-C IN GND
- AV4 SLOW SW GND
- AV4 L-IN GND
- AV4 R-IN GND
- VIDEO OUT GND
- REL GND
- ERR GND

F BOARD
TNP A1068

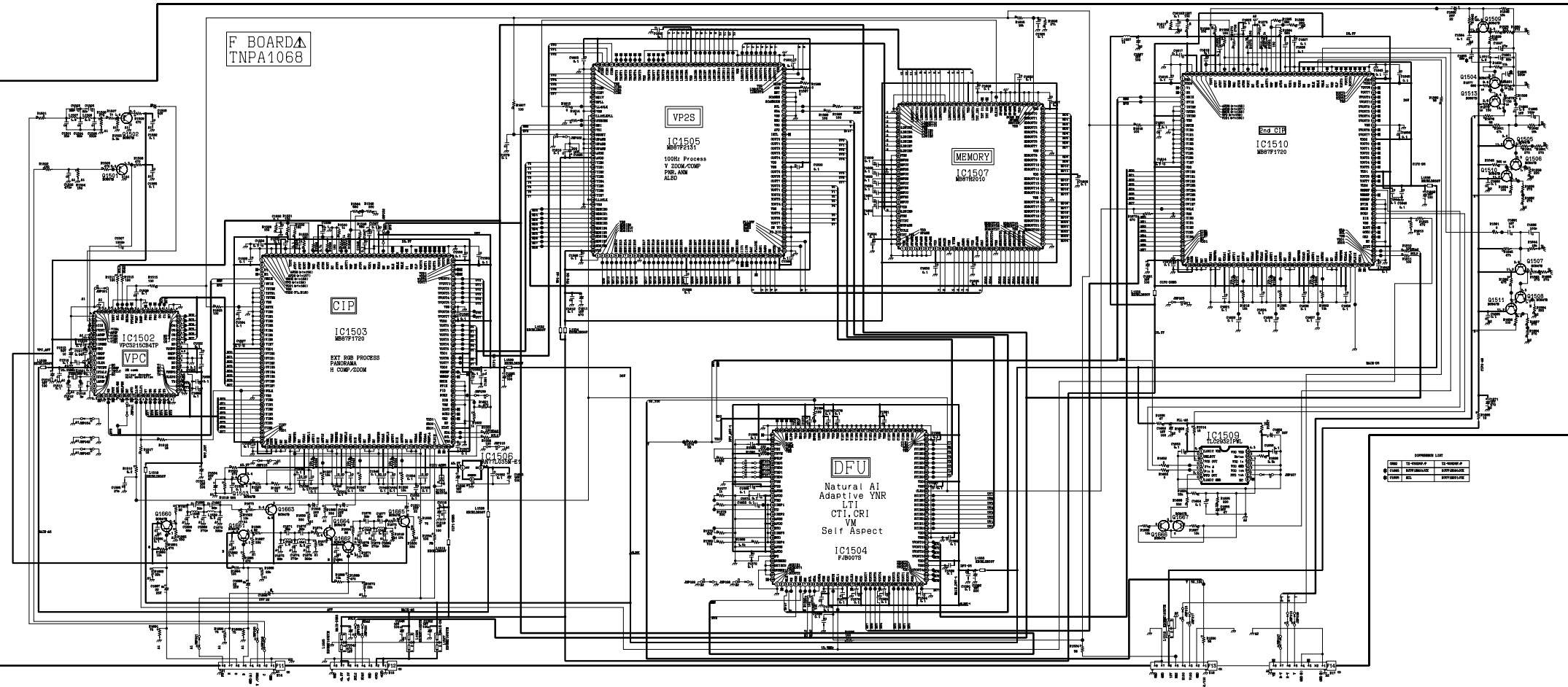

Y - BOARD TNPA1353

TRAN'S	
Q901	C1
Q902	B1
Q903	B1
Q904	C1
Q906	C1
Q908	D1
Q909	D1
Q3351	A2
Q3352	A2
DIODE'S	
D351	B3
D352	B3
D361	A2
D362	A2
D371	C3
D372	C2
D373	C3
D374	A1
D375	B2
D387	B1
D901	C1
D902	C1
D903	C1
D910	C1
D911	D2
D3351	A2
D3352	A3
D3353	A1
D3354	C3
T.P.'S	
TPY1	B3
TPY2	A2
TPY3	C2
TPKR	B3
TPKG	B2
TPKB	C2
I.C.'S	
IC351	B2
IC361	A1
IC371	C3
IC381	C3

A

B

C

D

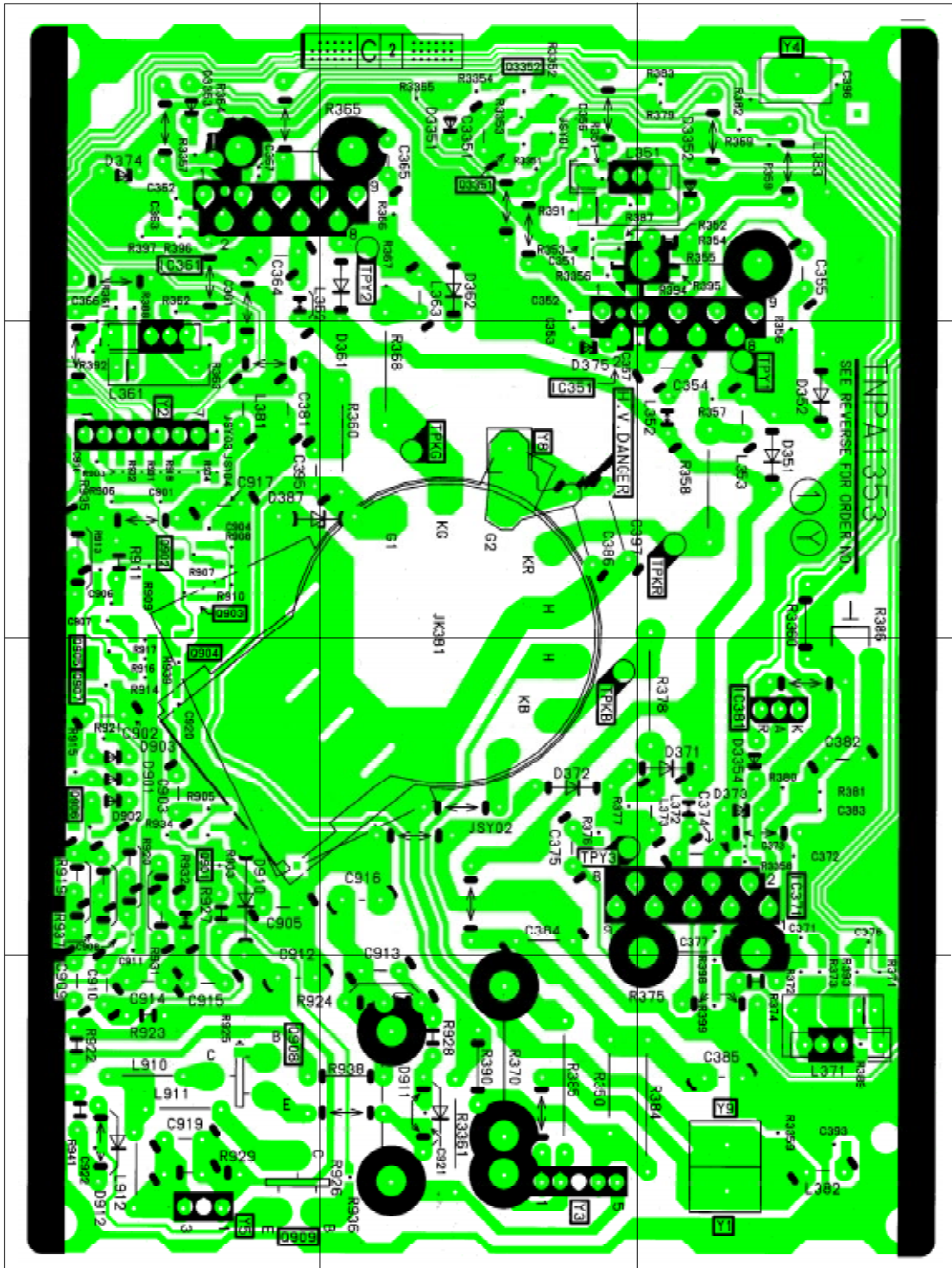

1

2

3

CONDUCTOR VIEWS

E - BOARD TNPH0176

TRAN'S		DIODE'S			
Q101	A3	D001	A1	D2364	A6
Q103	A3	D002	A1	D3005	B1
Q104	A3	D252	E5	D3006	B2
Q251	D4	D253	E5	D3008	B4
Q252	D4	D254	E5	D3009	A3
Q253	E4	D255	E4	D3010	A3
Q254	E4	D256	E4	D3011	B1
Q281	E3	D281	E4	D3803	A5
Q282	D3	D282	E4	D3804	A5
Q400	B5	D283	E4	D3805	C5
Q401	A4	D284	E2	D3990	A4
Q601	B5	D285	E3		
Q602	B4	D286	E2		
Q603	C4	D400	B5	I.C.'S	
Q604	C4	D401	A4	IC251	E4
Q607	C4	D402	A4	IC451	A4
Q608	D4	D403	B4	IC601	C4
Q1001	C7	D404	A4	IC1001	C7
Q1105	C6	D405	A6	IC1101	D5
Q1106	C6	D408	B5	IC1102	E5
Q1107	C6	D411	A4	IC1103	E5
Q1108	A5	D601	B4	IC1104	D5
Q1109	A5	D603	D5	IC1105	B6
Q1110	A5	D605	B5	IC1106	D6
Q1111	C5	D607	B5	IC1901	C6
Q1112	E5	D609	B5	IC2101	B3
Q1113	E5	D610	C4	IC2351	A6
Q1114	C6	D611	C4	IC3001	B1
Q1116	C6	D612	C4	IC3801	A2
Q1118	D6	D615	B5	IC3802	C5
Q1901	C6	D616	B5	IC3805	B5
Q2101	B2	D617	D5	IC3806	D1
Q2102	C2	D618	C4		
Q2103	B2	D620	B5	T.P.'S	
Q2301	B2	D651	C4	TPE1	A2
Q2302	A2	D652	C4	TPE2	B3
Q2305	A2	D653	B4	TPE23	D6
Q2307	A3	D1001	C7		
Q2308	A3	D1101	C1		
Q2351	A6	D1102	C1		
Q2352	A6	D1103	C1		
Q3001	C1	D1104	A6		
Q3002	B1	D1105	A6		
Q3003	B2	D1106	B6		
Q3005	D1	D1107	C5		
Q3006	D1	D1108	C6		
Q3007	D1	D1109	D6		
Q3008	D1	D1110	D6		
Q3010	A3	D1111	D6		
Q3011	B2	D1112	D6		
Q3012	B2	D2101	B2		
Q3013	B2	D2102	B2		
Q3014	D1	D2301	A2		
Q3801	A5	D2302	A2		
Q3990	A4	D2351	A6		

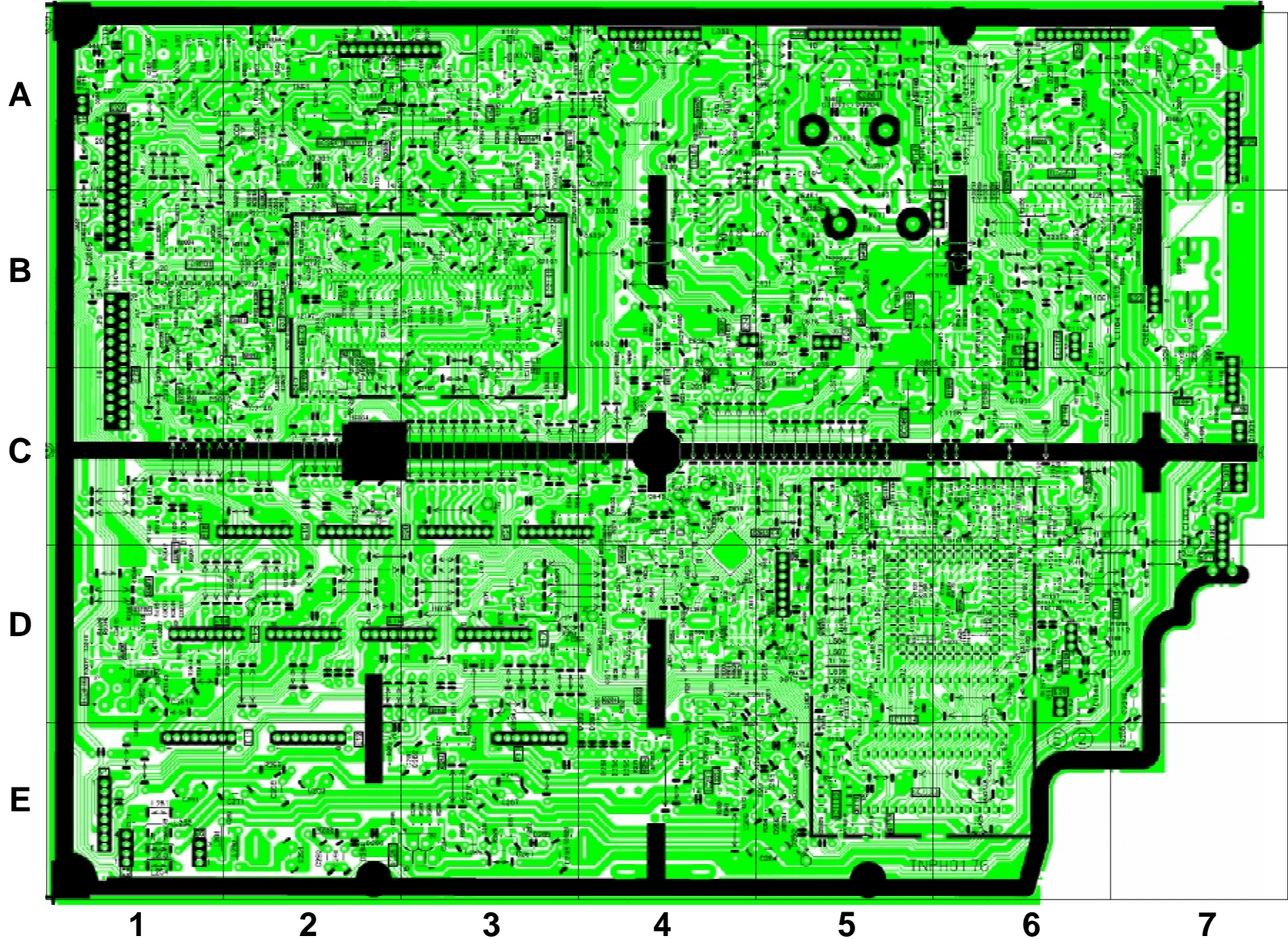

D - BOARD TNPA0876

DIODE'S		TRAN'S	
D391	D1	Q502	B4
D502	B4	Q552	A3
D503	B3	Q553	A1
D504	B3	Q554	A1
D505	E4	Q701	D4
D556	D2	Q801	B5
D559	E3	Q803	A4
D560	A1	Q804	A4
D561	B2	Q845	E7
D563	A3	Q846	C7
D565	A1	Q847	E7
D566	A1	Q848	D7
D571	A2	Q849	E5
D575	A1	Q850	E5
D591	C1	Q852	E7
D592	D1	Q854	C4
D701	D4	Q3901	E2
D807	A6	Q3902	D1
D808	A4	Q3903	E1
D809	A4	Q3904	D1
D810	A5	Q3905	D2
D812	A4	Q3906	E2
D813	A4	Q3907	E2
D814	B4	Q3908	E2
D815	B4	Q3911	D2
D817	B6	Q3912	E2
D818	A5	Q3916	E1
D819	A4		
D820	B4	T.P.'S	
D821	B4	TPDG1	A1
D845	C7	TPDG2	B1
D846	D7	TPDG11D1	
D847	D7	TPDG12E1	
D848	D6	TPDG13D1	
D849	D6	TPDG14D2	
D851	D4	TPDG15E2	
D852	C4		
D853	E6	I.C.'S	
D854	D7	IC801	A4
D855	D6	IC845	C4
D856	E7	IC852	E6
D857	E6	IC3901	E1
D858	E5		
D860	E5		
D861	E7		
D3901	D1		
D3907	D2		
D3908	D2		
D3909	E2		
D3910	D3		
D3911	C2		
D3912	E3		
D3915	E2		
D3918	E2		

A
B
C
D
E

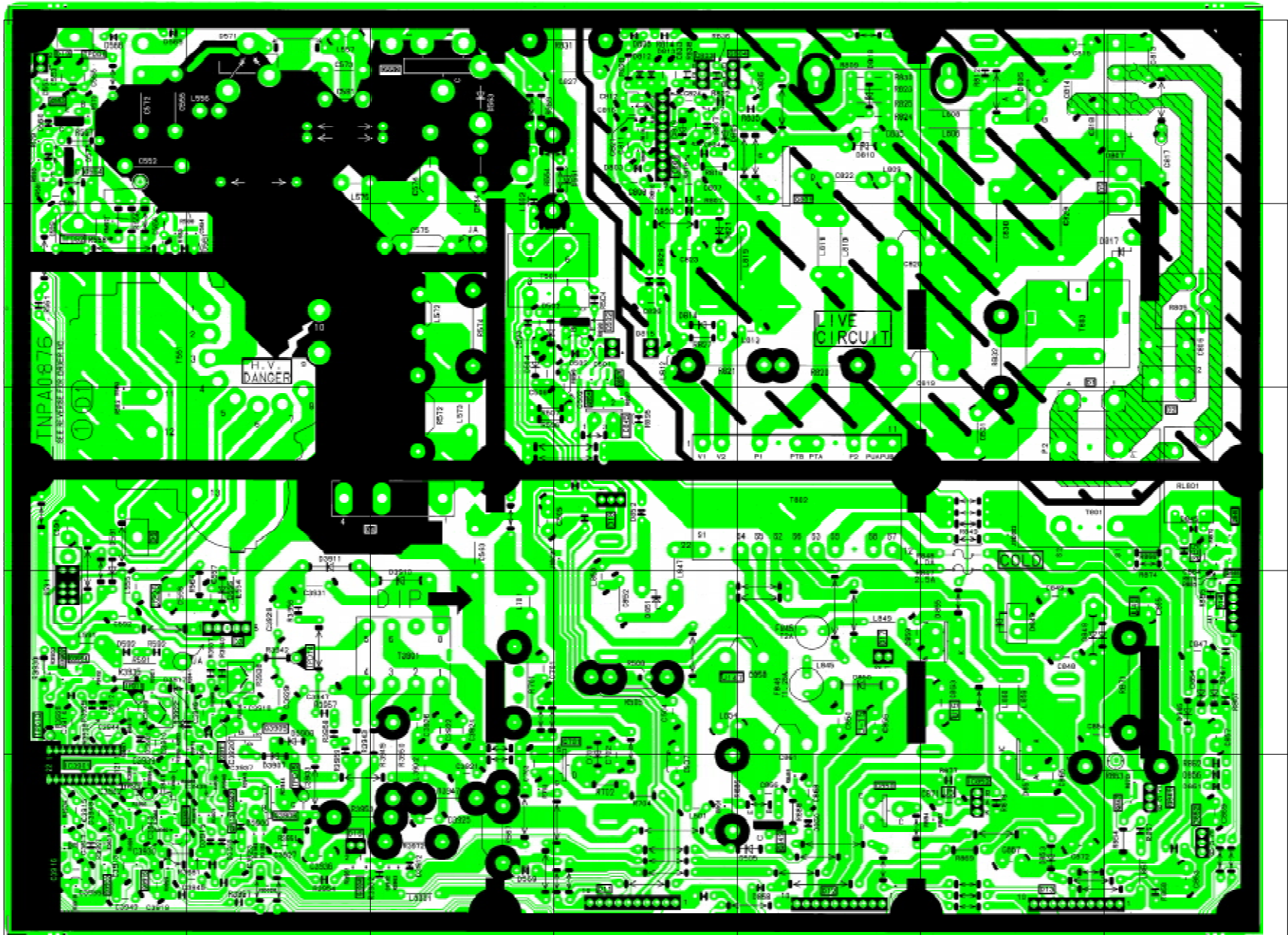

1 2 3 4 5 6 7

H - BOARD TNPA1047

TRAN'S	
Q2401	A2
Q2407	A3
Q2408	A3
Q2409	A3
Q2410	A3
Q2411	A3
Q2412	A3
Q3401	B1
Q3402	C1
Q3403	B1
Q3404	C1
Q3405	C3
Q3406	C3

DIODE'S	
D2401	A2
D2403	A3
D2404	A3
D2405	A3
D2406	A3
D2407	A3
D2408	A3
D3401	C3
D3402	C3

T.P.'S	
TPH1	D1
TPH2	A2
TPH3	D1
TPH004	D1
TPH005	D1

I.C.'S	
IC2401	A2
IC2402	A3

A

B

C

D

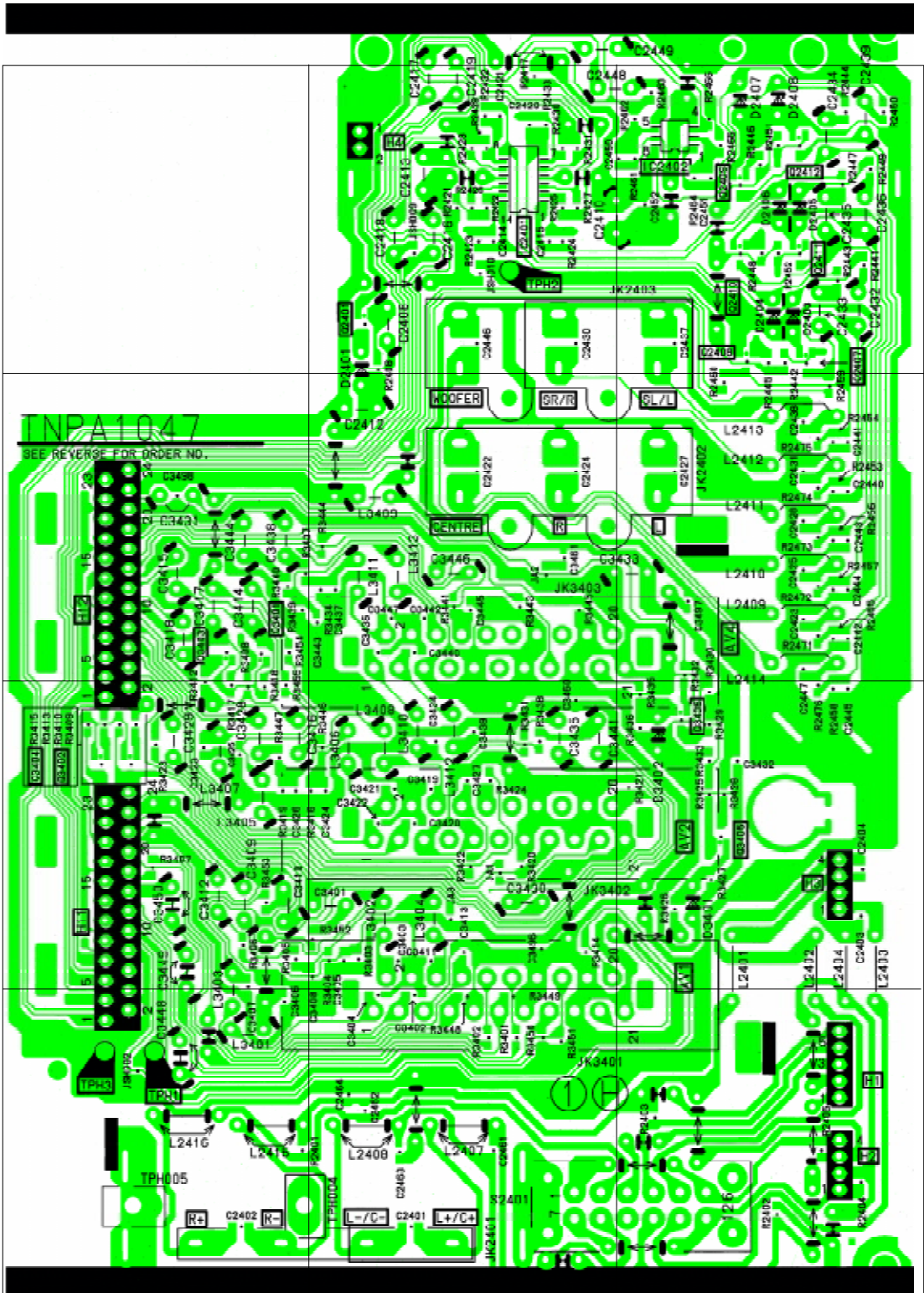

1

2

3

G - BOARD TNPA0877

TRAN'S	
Q1801	C2
Q1802	C2
Q1803	C3
Q1804	B2
Q1805	B3
Q1806	B3
Q2502	B2
Q2505	A2
Q2506	B2
Q2507	A1
I.C.'S	
IC1801	C2
IC1802	C1
IC2501	B2
DIODE'S	
D1801	B2
D1802	B2

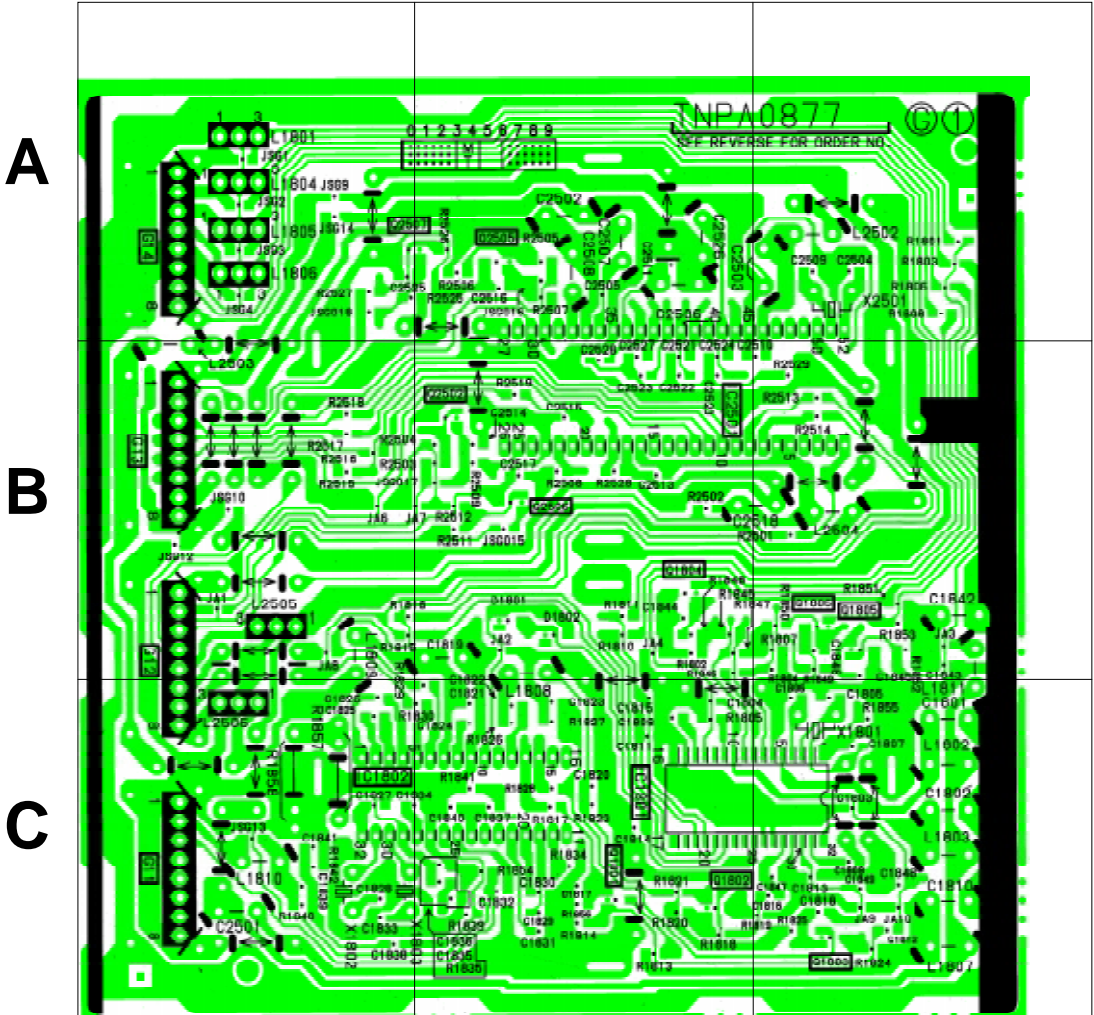

1

2

3

D - BOARD TNPA1014

DIODE'S	TRAN'S
D503	A4
D504	A3
D505	C3
D551	A4
D556	C1
D559	E3
D560	D1
D561	D1
D563	A3
D565	A1
D566	A1
D571	A2
D575	C1
D701	E2
D803	C4
D807	B6
D808	B4
D809	B4
D810	B4
D812	B4
D813	B4
D814	C4
D815	C3
D817	C6
D818	B4
D819	B4
D820	C4
D821	C4
D845	D7
D846	D7
D847	E6
D848	E5
D849	E5
D850	E4
D851	D3
D852	D3
D853	E7
D854	E6
D855	E3
D856	E7
D857	E3
D858	E5
D860	E1
D861	E7
	I.C.'S
D810	B4
D812	B4
D813	B4
D814	C4
D815	C3
D817	C6
D818	B4
D819	B4
D820	C4
D821	C4
D845	D7
D846	D7
D847	E6
D848	E5
D849	E5
D850	E4
D851	D3
D852	D3
D853	E7
D854	E6
D855	E3
D856	E7
D857	E3
D858	E5
D860	E1
D861	E7
	T.P.'S
D818	TPDG1
D819	TPDG2

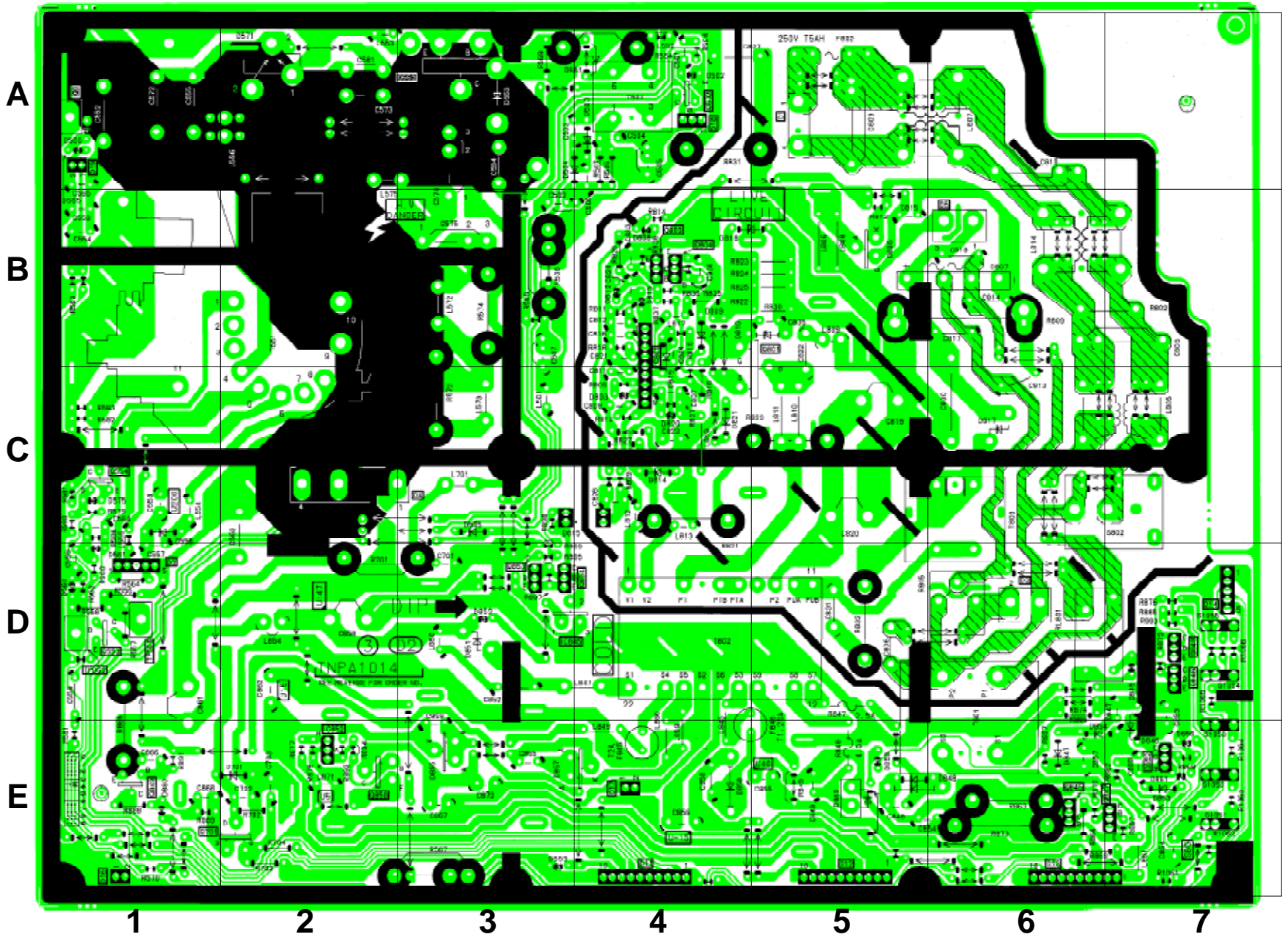

F - BOARD TNPA1068

TRAN'S	
Q1663	B2
Q1664	B2
Q1665	B2
Q1666	C1
Q1667	C1

I.C.'S	
IC1502	B3
IC1503	C3
IC1504	D1
IC1505	D2
IC1506	C2
IC1509	C1
IC1510	C1

A

B

C

D

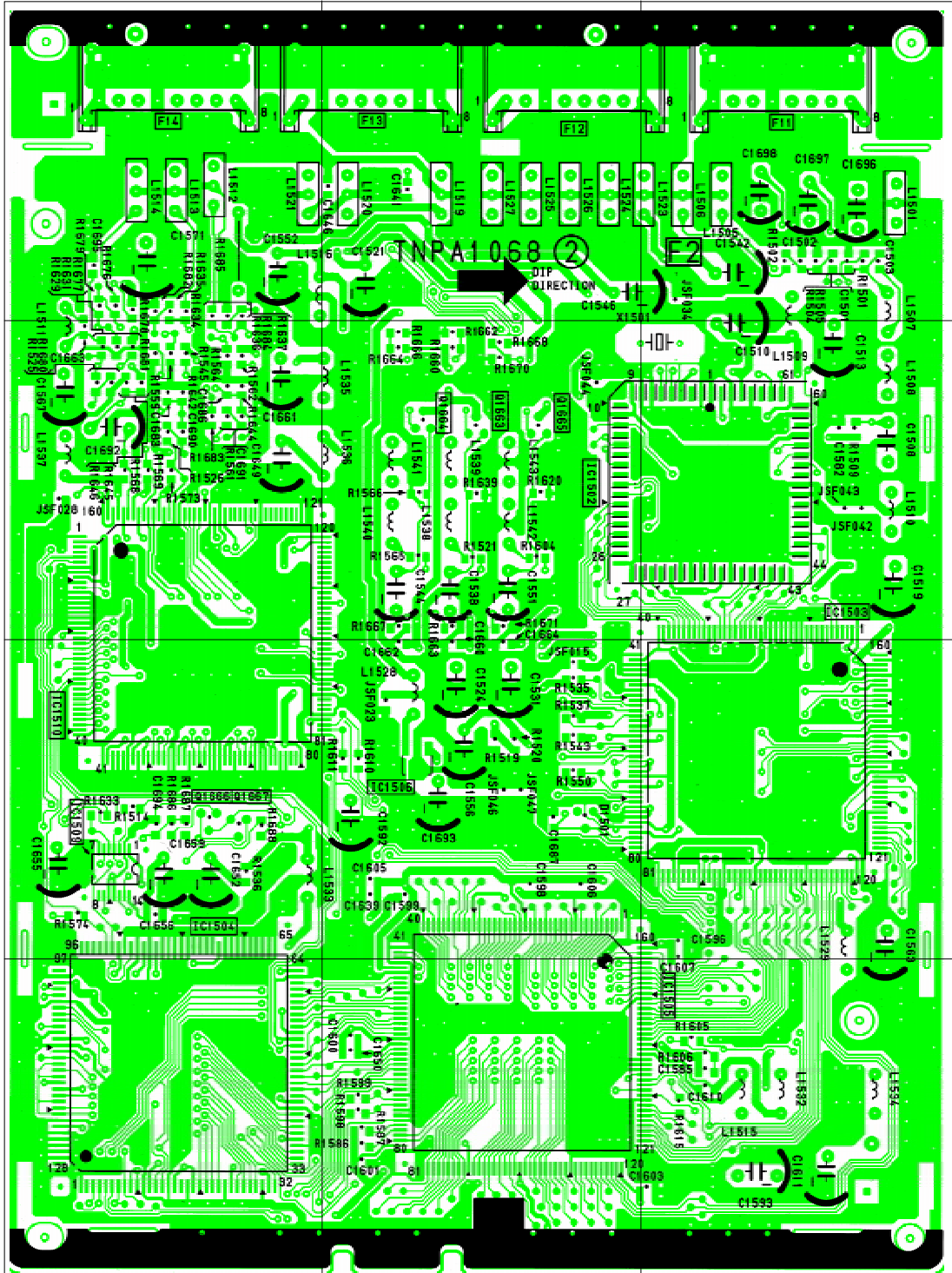

1

2

3

F - BOARD TNPA1068

TRAN'S	
Q1501	D3
Q1502	C3
Q1503	B2
Q1504	C1
Q1505	C1
Q1506	C1
Q1507	C1
Q1508	C1
Q1509	C1
Q1510	D1
Q1511	D1
Q1519	D1
Q1660	C2
Q1661	C2
Q1662	C2
I.C.'S	
IC1507	B2

A

B

C

D

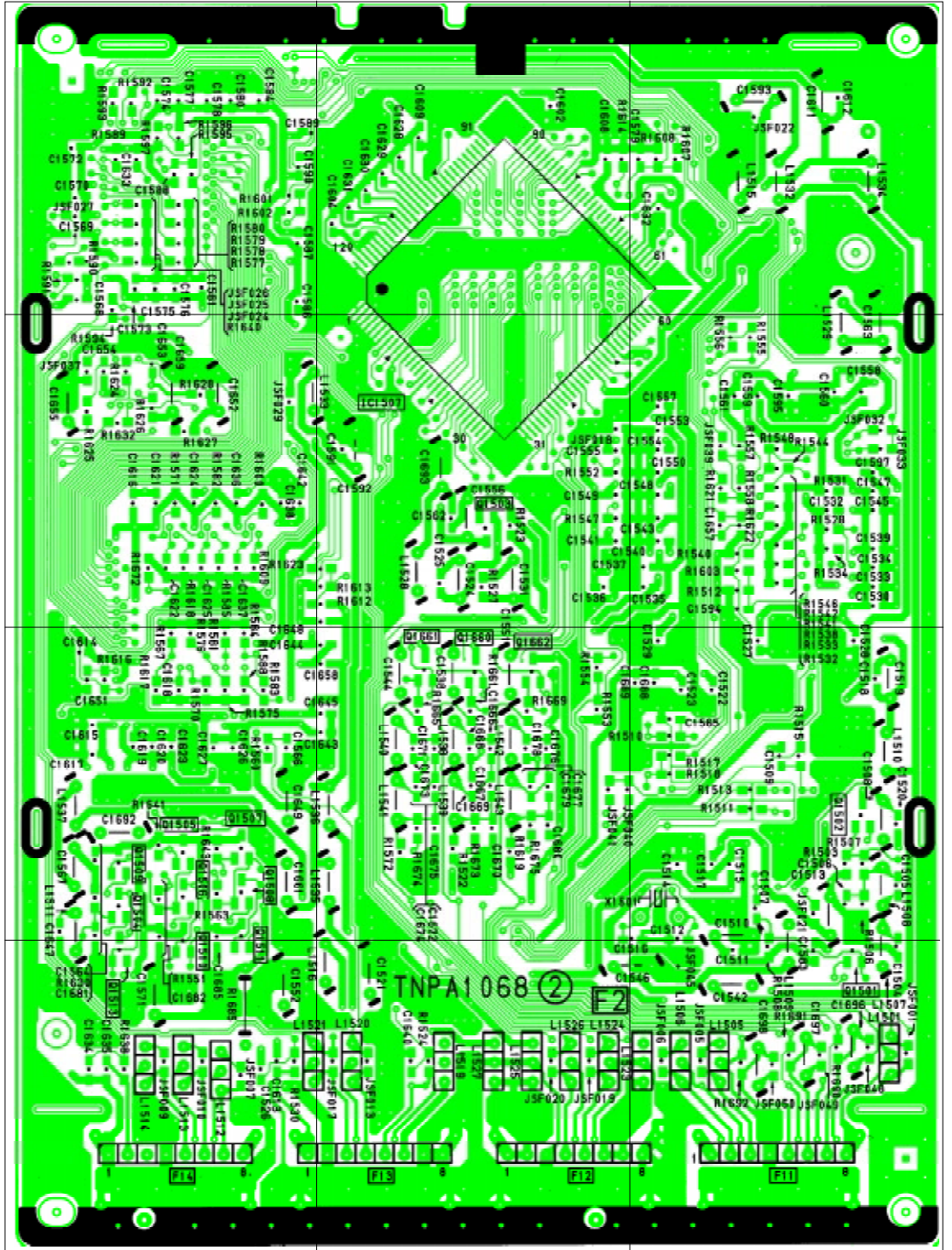

1

2

3

M - BOARD TNPA1048

TRAN'S	
Q2401	A2
Q2407	A3
Q2408	A3
Q2409	A3
Q2410	A3
Q2411	A3
Q2412	A3
Q3401	B1
Q3402	C1
Q3403	B1
Q3404	C1
Q3405	C3
Q3406	C3

DIODE'S	
D2401	A2
D2403	A3
D2404	A3
D2405	A3
D2406	A3
D2407	A3
D2408	A3
D3401	C3
D3402	C3

T.P.'S	
TPH1	D1
TPH2	A2
TPH3	D1
TPH004	D1
TPH005	D1

I.C.'S	
IC2401	A2
IC2402	A3

A

B

C

D

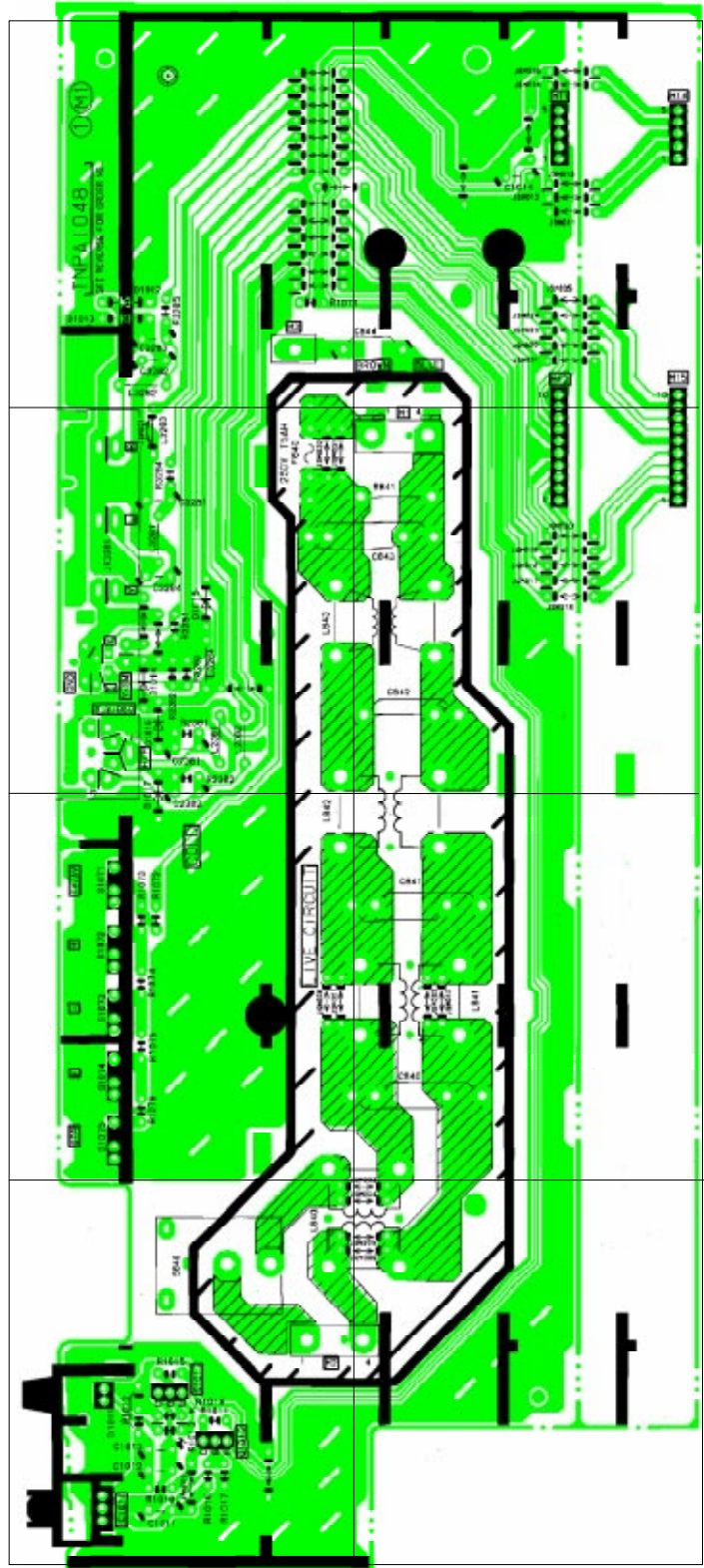

1

2